



# Dell™ OptiPlex™ 745

## Quick Reference Guide

**Models DCTR, DCNE, DCSM, and DCCY**

[www.dell.com](http://www.dell.com) | [support.dell.com](http://support.dell.com)

## Notes, Notices, and Cautions

-  **NOTE:** A NOTE indicates important information that helps you make better use of your computer.
-  **NOTICE:** A NOTICE indicates potential damage to hardware or loss of data and tells you how to avoid the problem.
-  **CAUTION:** A CAUTION indicates a potential for property damage, personal injury, or death.

If you purchased a Dell™ n Series computer, any references in this document to Microsoft® Windows® operating systems are not applicable.

---

**Information in this document is subject to change without notice.**  
© 2006 Dell Inc. All rights reserved.

Reproduction in any manner whatsoever without the written permission of Dell Inc. is strictly forbidden.

Trademarks used in this text: *Dell*, the *DELL* logo, *Inspiron*, *Dell Precision*, *Dimension*, *OptiPlex*, *Latitude*, *PowerEdge*, *PowerVault*, *PowerApp*, and *Dell OpenManage* are trademarks of Dell Inc.; *Intel*, *Pentium*, and *Celeron* are registered trademarks of Intel Corporation; *Microsoft* and *Windows* are registered trademarks of Microsoft Corporation.

Other trademarks and trade names may be used in this document to refer to either the entities claiming the marks and names or their products. Dell Inc. disclaims any proprietary interest in trademarks and trade names other than its own.

**Models DCTR, DCNE, DCSM, and DCCY**

**August 2006      P/N JH470      Rev. A00**

# Contents

<b>Finding Information</b> . . . . .	<b>5</b>
<b>System Views</b> . . . . .	<b>8</b>
Mini Tower Computer — Front View . . . . .	8
Mini Tower Computer — Back View . . . . .	10
Mini Tower Computer — Back-Panel Connectors . . . . .	11
Desktop Computer — Front View. . . . .	13
Desktop Computer — Back View. . . . .	14
Desktop Computer — Back-Panel Connectors . . . . .	15
Small Form Factor Computer — Front View . . . . .	17
Small Form Factor Computer — Back View . . . . .	18
Small Form Factor Computer — Back-Panel Connectors . . . . .	19
Ultra-Small Form Factor Computer — Front View . . . . .	21
Ultra-Small Form Factor Computer — Side View. . . . .	22
Ultra-Small Form Factor Computer — Back View . . . . .	23
Ultra-Small Form Factor Computer — Back-Panel Connectors . . . . .	23
<b>Removing the Computer Cover.</b> . . . . .	<b>24</b>
Before You Begin . . . . .	25
Mini Tower Computer. . . . .	26
Desktop Computer . . . . .	27
Small Form Factor Computer . . . . .	28
Ultra-Small Form Factor Computer . . . . .	30
<b>Inside Your Computer</b> . . . . .	<b>32</b>
Mini Tower Computer. . . . .	32
Desktop Computer . . . . .	35
Small Form Factor Computer . . . . .	38
Ultra-Small Form Factor Computer . . . . .	41
<b>Setting Up Your Computer</b> . . . . .	<b>43</b>
Set Up Your Keyboard and Mouse . . . . .	45
Set Up Your Monitor . . . . .	45
Power Connections. . . . .	46
<b>Solving Problems</b> . . . . .	<b>46</b>
Dell Diagnostics. . . . .	46
System Lights . . . . .	49

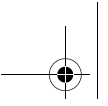

Diagnostic Lights . . . . .	50
Beep Codes . . . . .	52
Resolving Software and Hardware Incompatibilities . . . . .	53
Using Microsoft Windows XP System Restore . . . . .	54
Reinstalling Microsoft Windows XP . . . . .	55
<b>Using the Drivers and Utilities CD . . . . .</b>	<b>58</b>
Drivers for Your Computer . . . . .	58
 Index . . . . .	 59

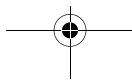

## Finding Information

**NOTE:** Some features or media may be optional and may not ship with your computer. Some features or media may not be available in certain countries.

**NOTE:** Additional information may ship with your computer.

### What Are You Looking For?

- A diagnostic program for my computer
- Drivers for my computer
- My computer documentation
- My device documentation
- Desktop System Software (DSS)

### Find It Here

#### Drivers and Utilities CD (ResourceCD)

**NOTE:** The *Drivers and Utilities* CD may be optional and may not ship with your computer.

Documentation and drivers are already installed on your computer. You can use the CD to reinstall drivers (see "Using the Drivers and Utilities CD" on page 58), run the Dell Diagnostics (see "Dell Diagnostics" on page 46), or access your documentation.

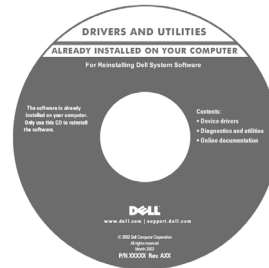

Readme files may be included on your CD to provide last-minute updates about technical changes to your computer or advanced technical reference material for technicians or experienced users.

**NOTE:** Drivers and documentation updates can be found at [support.dell.com](http://support.dell.com).

- How to remove and replace parts
- Specifications
- How to configure system settings
- How to troubleshoot and solve problems

#### Dell™ OptiPlex™ User's Guide

*Microsoft Windows XP Help and Support Center*

**1** Click **Start**→ **Help and Support**→ **Dell User and System Guides**→ **System Guides**.

**2** Click the *User's Guide* for your computer.

The *User's Guide* is also available on the optional *Drivers and Utilities* CD.

**What Are You Looking For?**

- Warranty information
- Terms and Conditions (U.S. only)
- Safety instructions
- Regulatory information
- Ergonomics information
- End User License Agreement

**Find It Here**

**Dell™ Product Information Guide**

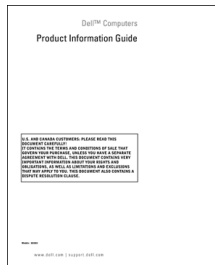

- How to reinstall my operating system

**Operating System CD**

**NOTE:** The *Operating System CD* may be optional and may not ship with your computer.

The operating system is already installed on your computer. To reinstall your operating system, use the *Operating System CD* (see "Reinstalling Microsoft Windows XP" on page 55).



After you reinstall your operating system, use the optional *Drivers and Utilities CD (ResourceCD)* to reinstall drivers for the devices that came with your computer. For more information, see

"Drivers and Utilities CD (ResourceCD)" on page 5.

Your operating system product key label is located on your computer (see "Service Tag and Microsoft® Windows® Product Key" on page 7).

**NOTE:** The color of your *Operating System CD* varies according to the operating system you ordered.

- How to use Windows XP
- How to work with programs and files
- How to personalize my desktop

**Windows Help and Support Center**

- 1 Click **Start** → **Help and Support**.
- 2 Type a word or phrase that describes your problem and click the arrow icon.
- 3 Click the topic that describes your problem.
- 4 Follow the instructions on the screen.

---

**What Are You Looking For?**

- Service Tag and Express Service Code
  - Microsoft Windows Product Key Label
- 
- Solutions — Troubleshooting hints and tips, articles from technicians, online courses, and frequently asked questions
  - Community — Online discussion with other Dell customers
  - Upgrades — Upgrade information for components, such as the memory, hard drive, and operating system
  - Customer Care — Contact information, service call and order status, and warranty and repair information
  - Service and support — Service call status, support history, service contract, and online discussions with support
  - Reference — Computer documentation, details on my computer configuration, product specifications, and white papers
  - Downloads — Certified drivers, patches, and software updates
  - Desktop System Software (DSS)— If you reinstall the operating system on your computer, you should also reinstall the DSS utility. DSS automatically detects your computer and operating system and installs the updates appropriate for your configuration, providing critical updates for your operating system and support for Dell™ 3.5-inch USB floppy drives, Intel® processors, optical drives, and USB devices. DSS is necessary for correct operation of your Dell computer.

---

**Find It Here**
**Service Tag and Microsoft® Windows® Product Key**

These labels are located on your computer.

- Use the Service Tag to identify your computer when you use [support.dell.com](http://support.dell.com) or contact support.

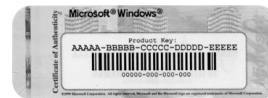

- Enter the Express Service Code to direct your call when contacting support.

**Dell Support Website — [support.dell.com](http://support.dell.com)**

**NOTE:** Select your region or business segment to view the appropriate support site.

To download Desktop System Software:

- 1** Go to [support.dell.com](http://support.dell.com), select your region or business segment, then enter your Service Tag.
- 2** Select **Drivers & Downloads**, then click **Go**.
- 3** Click your operating system, and then search for the keyword *Desktop System Software*.

**NOTE:** The [support.dell.com](http://support.dell.com) user interface may vary depending on your selections.



---

## System Views

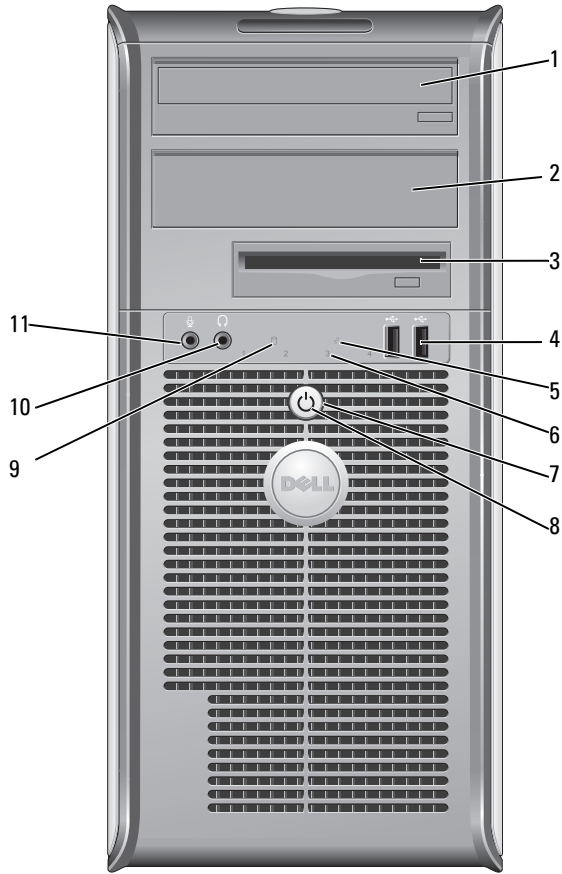
### Mini Tower Computer — Front View





- |    |                           |  |
|----|---------------------------|--|
| 1  | 5.25-inch drive bay       | Can contain an optical drive. Insert a CD or DVD (if supported) into this drive.   |
| 2  | 5.25-inch drive bay       | Can contain an optical drive. Insert a CD or DVD (if supported) into this drive.   |
| 3  | 3.5-inch drive bay        | Can contain an optional floppy drive or optional media card reader.  |
| 4  | USB 2.0 connectors (2)    | Use the front USB connectors for devices that you connect occasionally, such as joysticks or cameras, or for bootable USB devices (see your online <i>User's Guide</i> for more information on booting to a USB device).<br><br>It is recommended that you use the back USB connectors for devices that typically remain connected, such as printers and keyboards.  |
| 5  | LAN indicator light       | This light indicates that a LAN (local area network) connection is established.  |
| 6  | diagnostic lights         | Use the lights to help you troubleshoot a computer problem based on the diagnostic code. For more information, see "Diagnostic Lights" on page 50.   |
| 7  | power button              | Press this button to turn on the computer.<br><br> <b>NOTICE:</b> To avoid losing data, do not turn off the computer by pressing the power button. Instead, perform an operating system shutdown. See "Before You Begin" on page 25 for more information.<br><br> <b>NOTICE:</b> If your operating system has ACPI enabled, when you press the power button the computer will perform an operating system shutdown.  |
| 8  | power light               | The power light illuminates and blinks or remains solid to indicate different operating modes: <ul style="list-style-type: none"> <li>• No light — The computer is turned off.</li> <li>• Steady green — The computer is in a normal operating state.</li> <li>• Blinking green — The computer is in a power-saving mode.</li> <li>• Blinking or solid amber — See your online <i>User's Guide</i>.</li> </ul> <p>To exit from a power-saving mode, press the power button or use the keyboard or the mouse if it is configured as a wake device in the Windows Device Manager. For more information about sleep modes and exiting from a power-saving mode, see your online <i>User's Guide</i>.</p> <p>See "System Lights" on page 49 for a description of light codes that can help you troubleshoot problems with your computer.</p> |
| 9  | hard-drive activity light | This light flickers when the hard drive is being accessed.   |
| 10 | headphone connector       | Use the headphone connector to attach headphones and most kinds of speakers.   |
| 11 | microphone connector      | Use the microphone connector to attach a microphone.   |

## Mini Tower Computer — Back View

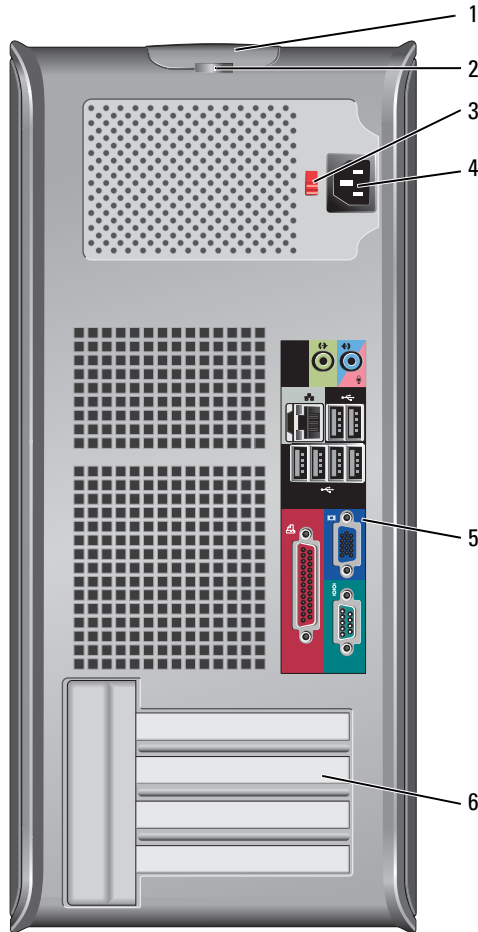

- 1 cover-release latch This latch allows you to open the computer cover.
- 2 padlock ring Insert a padlock to lock the computer cover.

- 3 voltage selection switch Your computer is equipped with a manual voltage-selection switch.  
To help avoid damaging a computer with a manual voltage-selection switch, set the switch for the voltage that most closely matches the AC power available in your location.  
**➡ NOTICE:** The voltage selection switch must be set to the 115-V position even though the AC power available in Japan is 100 V.  
Also, ensure that your monitor and attached devices are electrically rated to operate with the AC power available in your location.
- 4 power connector Insert the power cable.
- 5 back-panel connectors Plug serial, USB, and other devices into the appropriate connectors (see "Mini Tower Computer — Back-Panel Connectors" on page 11).
- 6 card slots Access connectors for any installed PCI and PCI Express cards.

### Mini Tower Computer — Back-Panel Connectors

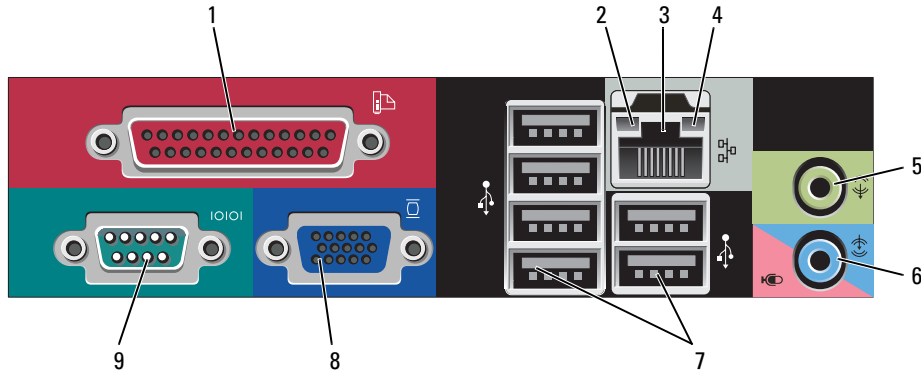

- 1 parallel connector Connect a parallel device, such as a printer, to the parallel connector. If you have a USB printer, plug it into a USB connector.  
**NOTE:** The integrated parallel connector is automatically disabled if the computer detects an installed card containing a parallel connector configured to the same address. For more information, see your online User's Guide.
- 2 link integrity light
  - Green — A good connection exists between a 10-Mbps network and the computer.
  - Orange — A good connection exists between a 100-Mbps network and the computer.
  - Yellow — A good connection exists between a 1-Gbps (or 1000-Mbps) network and the computer.
  - Off — The computer is not detecting a physical connection to the network.

- |   |                              |   |
|---|------------------------------|---|
| 3 | network adapter connector    | <p>To attach your computer to a network or broadband device, connect one end of a network cable to either a network jack or your network or broadband device. Connect the other end of the network cable to the network adapter connector on the back panel of your computer. A click indicates that the network cable has been securely attached.</p> <p><b>NOTE:</b> Do not plug a telephone cable into the network connector.</p> <p>On computers with a network connector card, use the connector on the card.</p> <p>It is recommended that you use Category 5 wiring and connectors for your network. If you must use Category 3 wiring, force the network speed to 10 Mbps to ensure reliable operation.</p> |
| 4 | network activity light       | <p>Flashes a yellow light when the computer is transmitting or receiving network data. A high volume of network traffic may make this light appear to be in a steady "on" state.</p>  |
| 5 | line-out connector           | <p>Use the green line-out connector to attach most speakers with integrated amplifiers.</p>   |
| 6 | line-in/microphone connector | <p>Use the blue and pink line-in/microphone connector to attach a record/playback device such as a cassette player, CD player, or VCR.; or a personal computer microphone for voice or musical input into a sound or telephony program.</p>   |
| 7 | USB 2.0 connectors (6)       | <p>Use the back USB connectors for devices that typically remain connected, such as printers and keyboards.</p>   |
| 8 | video connector              | <p>Plug the cable from your VGA-compatible monitor into the blue connector.</p> <p><b>NOTE:</b> If you purchased an optional graphics card, this connector will be covered by a cap. Connect your monitor to the connector on the graphics card. Do not remove the cap.</p> <p><b>NOTE:</b> If you are using a graphics card that supports dual monitors, use the y-cable that came with your computer.</p>   |
| 9 | serial connector             | <p>Connect a serial device, such as a handheld device, to the serial port. The default designations are COM1 for serial connector 1 and COM2 for serial connector 2.</p> <p>For more information, see your online <i>User's Guide</i>.</p>  |

## Desktop Computer — Front View

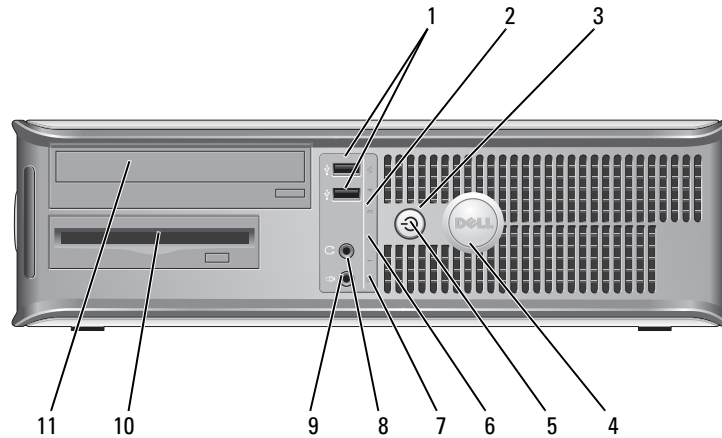

- |   |                        |   |
|---|------------------------|---|
| 1 | USB 2.0 connectors (2) | Use the front USB connectors for devices that you connect occasionally, such as joysticks or cameras, or for bootable USB devices (see your online <i>User's Guide</i> for more information about booting to a USB device).<br><br>It is recommended that you use the back USB connectors for devices that typically remain connected, such as printers and keyboards.  |
| 2 | LAN indicator light    | This light indicates that a LAN (local area network) connection is established.   |
| 3 | power button           | Press this button to turn on the computer.<br><br><b>➡ NOTICE:</b> To avoid losing data, do not turn off the computer by pressing the power button. Instead, perform an operating system shutdown. See "Before You Begin" on page 25 for more information.<br><br><b>➡ NOTICE:</b> If your operating system has ACPI enabled, when you press the power button the computer will perform an operating system shutdown. |
| 4 | Dell badge             | This badge can be rotated to match the orientation of your computer. To rotate, place fingers around the outside of the badge, press firmly, and turn the badge. You can also rotate the badge using the slot provided near the bottom of the badge.  |

- 5 power light  
The power light illuminates and blinks or remains solid to indicate different operating states:
  - No light — The computer is turned off.
  - Steady green — The computer is in a normal operating state.
  - Blinking green — The computer is in a power-saving mode.
  - Blinking or solid amber — See your online *User's Guide*.To exit from a power-saving mode, press the power button or use the keyboard or the mouse if it is configured as a wake device in the Windows Device Manager. For more information about sleep modes and exiting from a power-saving mode, see your online *User's Guide*.  
See "System Lights" on page 49 for a description of light codes that can help you troubleshoot problems with your computer.
- 6 diagnostic lights  
Use the lights to help you troubleshoot a computer problem based on the diagnostic code. For more information, see "Diagnostic Lights" on page 50.
- 7 hard-drive activity light  
This light flickers when the hard drive is being accessed.
- 8 headphone connector  
Use the headphone connector to attach headphones and most kinds of speakers.
- 9 microphone connector  
Use the microphone connector to attach a microphone.
- 10 3.5-inch drive bay  
Can contain an optional floppy drive or optional Media Card Reader.
- 11 5.25-inch drive bay  
Can contain an optical drive. Insert a CD or DVD (if supported) into this drive.

### Desktop Computer — Back View

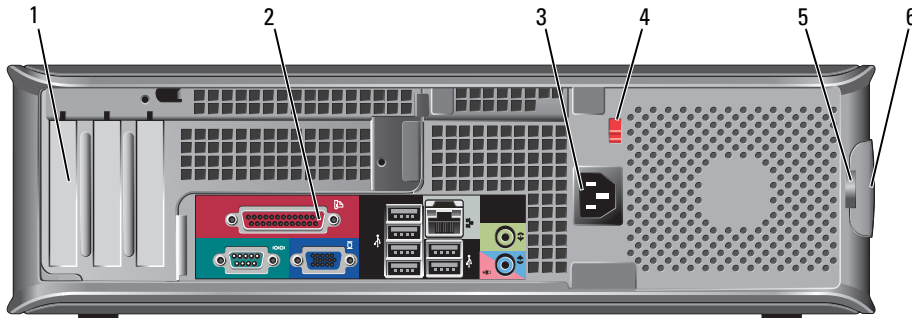

- 1 card slots Access connectors for any installed PCI and PCI Express cards.
- 2 back-panel connectors Plug serial, USB, and other devices into the appropriate connectors (see "Desktop Computer — Back-Panel Connectors" on page 15).
- 3 power connector Insert the power cable.
- 4 voltage selection switch Your computer is equipped with a manual voltage selection switch.  
To help avoid damaging a computer with a manual voltage selection switch, set the switch for the voltage that most closely matches the AC power available in your location.  
**➡ NOTICE:** The voltage selection switch must be set to the 115-V position even though the AC power available in Japan is 100 V.  
Also, ensure that your monitor and attached devices are electrically rated to operate with the AC power available in your location.
- 5 padlock ring Insert a padlock to lock the computer cover.
- 6 cover-release latch Allows you to open the computer cover.

### Desktop Computer — Back-Panel Connectors

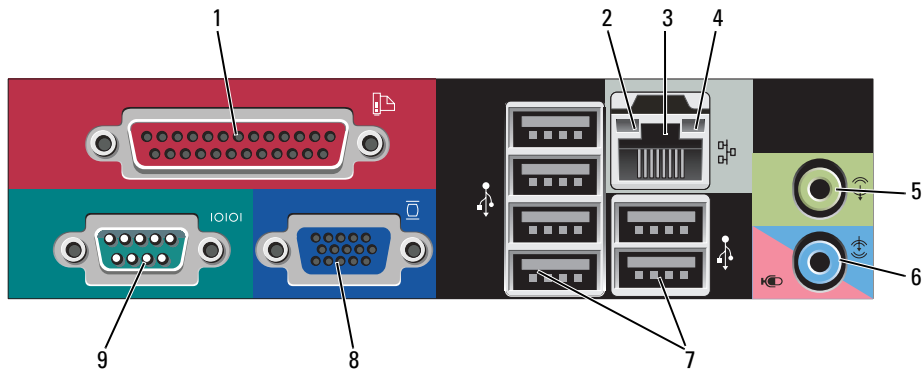

- |   |                              |   |
|---|------------------------------|---|
| 1 | parallel connector           | <p>Connect a parallel device, such as a printer, to the parallel connector. If you have a USB printer, plug it into a USB connector.</p> <p><b>NOTE:</b> The integrated parallel connector is automatically disabled if the computer detects an installed card containing a parallel connector configured to the same address. For more information, see your online <i>User's Guide</i>.</p>   |
| 2 | link integrity light         | <ul style="list-style-type: none"> <li>• Green — A good connection exists between a 10-Mbps network and the computer.</li> <li>• Orange — A good connection exists between a 100-Mbps network and the computer.</li> <li>• Yellow — A good connection exists between a 1-Gbps (or 1000-Mbps) network and the computer.</li> <li>• Off — The computer is not detecting a physical connection to the network.</li> </ul>  |
| 3 | network adapter connector    | <p>To attach your computer to a network or broadband device, connect one end of a network cable to either a network jack or your network or broadband device. Connect the other end of the network cable to the network adapter connector on the back panel of your computer. A click indicates that the network cable has been securely attached.</p> <p><b>NOTE:</b> Do not plug a telephone cable into the network connector.</p> <p>On computers with a network connector card, use the connector on the card.</p> <p>It is recommended that you use Category 5 wiring and connectors for your network. If you must use Category 3 wiring, force the network speed to 10 Mbps to ensure reliable operation.</p> |
| 4 | network activity light       | Flashes a yellow light when the computer is transmitting or receiving network data. A high volume of network traffic may make this light appear to be in a steady "on" state.   |
| 5 | line-out connector           | Use the green line-out connector to attach most speakers with integrated amplifiers.  |
| 6 | line-in/microphone connector | Use the blue and pink line-in/microphone connector to attach a record/playback device such as a cassette player, CD player, or VCR.; or a personal computer microphone for voice or musical input into a sound or telephony program.  |
| 7 | USB 2.0 connectors (6)       | Use the back USB connectors for devices that typically remain connected, such as printers and keyboards.  |
| 8 | video connector              | <p>Plug the cable from your VGA-compatible monitor into the blue connector.</p> <p><b>NOTE:</b> If you purchased an optional graphics card, this connector will be covered by a cap. Connect your monitor to the connector on the graphics card. Do not remove the cap.</p> <p><b>NOTE:</b> If you are using a graphics card that supports dual monitors, use the y-cable that came with your computer.</p>   |
| 9 | serial connector             | <p>Connect a serial device, such as a handheld device, to the serial port. The default designations are COM1 for serial connector 1 and COM2 for serial connector 2.</p> <p>For more information, see your online <i>User's Guide</i>.</p>  |



## Small Form Factor Computer — Front View

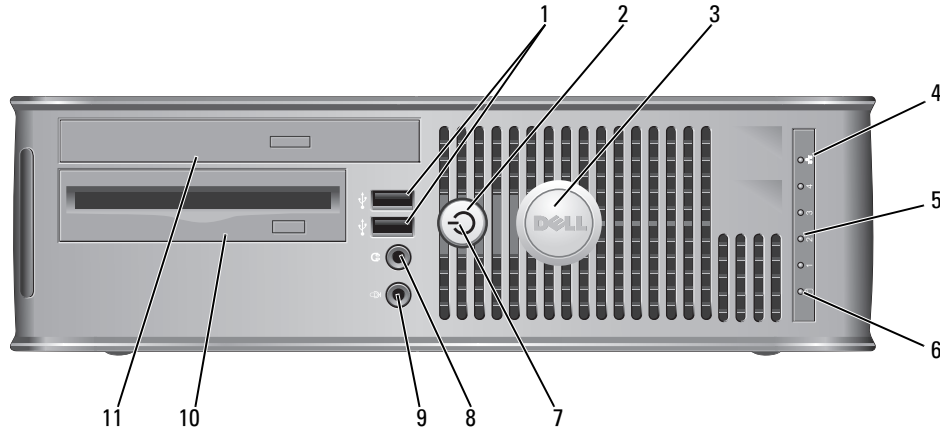

- |   |                           |   |
|---|---------------------------|---|
| 1 | USB 2.0 connectors (2)    | Use the front USB connectors for devices that you connect occasionally, such as joysticks or cameras, or for bootable USB devices (see your online <i>User's Guide</i> for more information about booting to a USB device).<br><br>It is recommended that you use the back USB connectors for devices that typically remain connected, such as printers and keyboards.                                    |
| 2 | power button              | Press to turn on the computer.<br><br>➔ <b>NOTICE:</b> To avoid losing data, do not turn off the computer by pressing the power button. Instead, perform an operating system shutdown. See "Before You Begin" on page 25 for more information.<br><br>➔ <b>NOTICE:</b> If your operating system has ACPI enabled, when you press the power button the computer will perform an operating system shutdown. |
| 3 | Dell badge                | Can be rotated to match the orientation of your computer. To rotate, place fingers around the outside of the badge, press firmly, and turn the badge. You can also rotate the badge using the slot provided near the bottom of the badge.   |
| 4 | LAN indicator light       | Indicates that a LAN (local area network) connection is established.  |
| 5 | diagnostic lights         | Use the lights to help you troubleshoot a computer problem based on the diagnostic code. For more information, see "Diagnostic Lights" on page 50.  |
| 6 | hard drive activity light | This light flickers when the hard drive is being accessed.  |

- 7 power light  
The power light illuminates and blinks or remains solid to indicate different operating states:
  - No light — The computer is turned off.
  - Steady green — The computer is in a normal operating state.
  - Blinking green — The computer is in a power-saving mode.
  - Blinking or solid amber — See your online *User's Guide*.To exit from a power-saving mode, press the power button or use the keyboard or the mouse if it is configured as a wake device in the Windows Device Manager. For more information about sleep modes and exiting from a power-saving mode, see your online *User's Guide*.  
See "System Lights" on page 49 for a description of light codes that can help you troubleshoot problems with your computer.
- 8 headphone connector Use the headphone connector to attach headphones and most kinds of speakers.
- 9 microphone connector Use the microphone connector to attach a microphone.
- 10 3.5-inch drive bay Can contain an optional floppy drive or optional media card reader.
- 11 5.25-inch drive bay Can contain an optical drive. Insert a CD or DVD (if supported) into this drive.

### Small Form Factor Computer — Back View

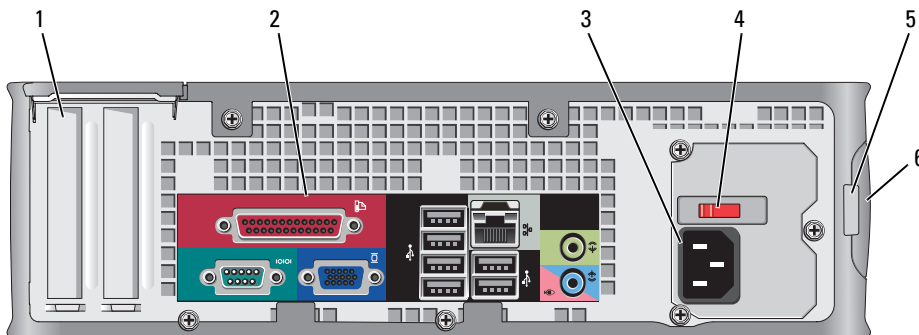

- 1 card slots Access connectors for any installed PCI and PCI Express cards.
- 2 back-panel connectors Plug serial, USB, and other devices into the appropriate connectors (see "Small Form Factor Computer — Back-Panel Connectors" on page 19).
- 3 power connector Insert the power cable.
- 4 voltage selection switch Your computer is equipped with a manual voltage-selection switch.  
To help avoid damaging a computer with a manual voltage selection switch, set the switch for the voltage that most closely matches the AC power available in your location.  
**➔ NOTICE:** The voltage selection switch must be set to the 115-V position even though the AC power available in Japan is 100 V.  
Also, ensure that your monitor and attached devices are electrically rated to operate with the AC power available in your location.
- 5 padlock ring Insert a padlock to lock the computer cover.
- 6 cover release latch Allows you to open the computer cover.

### Small Form Factor Computer — Back-Panel Connectors

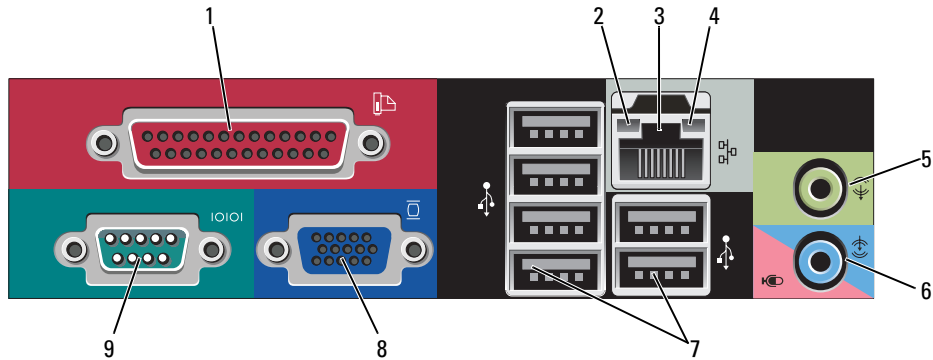

- |   |                              |   |
|---|------------------------------|---|
| 1 | parallel connector           | <p>Connect a parallel device, such as a printer, to the parallel connector. If you have a USB printer, plug it into a USB connector.</p> <p><b>NOTE:</b> The integrated parallel connector is automatically disabled if the computer detects an installed card containing a parallel connector configured to the same address. For more information, see your online <i>User's Guide</i>.</p>   |
| 2 | link integrity light         | <ul style="list-style-type: none"> <li>• Green — A good connection exists between a 10-Mbps network and the computer.</li> <li>• Orange — A good connection exists between a 100-Mbps network and the computer.</li> <li>• Yellow — A good connection exists between a 1-Gbps (or 1000-Mbps) network and the computer.</li> <li>• Off — The computer is not detecting a physical connection to the network.</li> </ul>  |
| 3 | network adapter connector    | <p>To attach your computer to a network or broadband device, connect one end of a network cable to either a network jack or your network or broadband device. Connect the other end of the network cable to the network adapter connector on the back panel of your computer. A click indicates that the network cable has been securely attached.</p> <p><b>NOTE:</b> Do not plug a telephone cable into the network connector.</p> <p>On computers with a network connector card, use the connector on the card.</p> <p>It is recommended that you use Category 5 wiring and connectors for your network. If you must use Category 3 wiring, force the network speed to 10 Mbps to ensure reliable operation.</p> |
| 4 | network activity light       | Flashes a yellow light when the computer is transmitting or receiving network data. A high volume of network traffic may make this light appear to be in a steady "on" state.   |
| 5 | line-out connector           | Use the green line-out connector (available on computers with integrated sound) to attach most speakers with integrated amplifiers.   |
| 6 | line-in/microphone connector | Use the blue and pink line-in/microphone connector (available on computers with integrated sound) to attach a record/playback device such as a cassette player, CD player, or VCR; or a personal computer microphone for voice or musical input into a sound or telephony program.  |
| 7 | USB 2.0 connectors (6)       | Use the back USB connectors for devices that typically remain connected, such as printers and keyboards.  |

- 8 video connector      Plug the cable from your VGA-compatible monitor into the blue connector.  
**NOTE:** If you purchased an optional graphics card, this connector will be covered by a cap. Connect your monitor to the connector on the graphics card. Do not remove the cap.  
**NOTE:** If you are using a graphics card that supports dual monitors, use the y-cable that came with your computer.
- 9 serial connector      Connect a serial device, such as a handheld device, to the serial port. The default designations are COM1 for serial connector 1 and COM2 for serial connector 2.  
For more information, see your online *User's Guide*.

### Ultra-Small Form Factor Computer — Front View

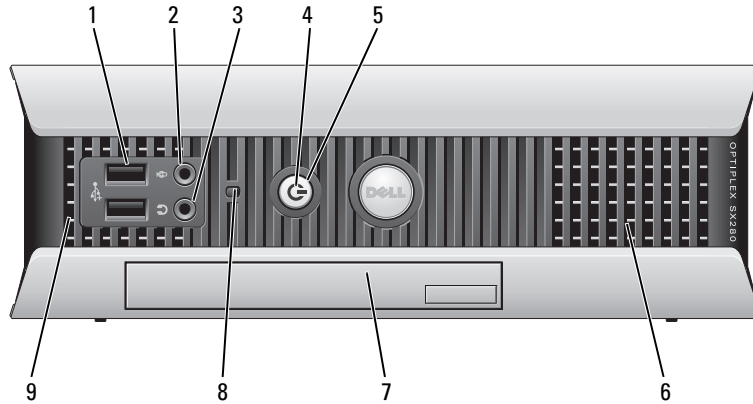

- 1 USB connectors (2)      Use the front USB connectors for devices that you connect occasionally, such as joysticks or cameras, or for bootable USB devices (see your online *User's Guide* for more information about booting to a USB device).  
It is recommended that you use the back USB connectors for devices that typically remain connected, such as printers and keyboards.
- 2 headphone connector      Use the headphone connector to attach headphones and most kinds of speakers.
- 3 microphone connector      Use the microphone connector to attach a microphone.

- 4 power light      The power light illuminates and blinks or remains solid to indicate different states:
  - No light — The computer is turned off.
  - Steady green — The computer is in a normal operating state.
  - Blinking green — The computer is in a power-saving mode.
  - Blinking or solid yellow — See your online *User's Guide*.

To exit from a power-saving mode, press the power button or use the keyboard or the mouse if it is configured as a wake device in the Windows Device Manager. For more information about sleep modes and exiting from a power-saving mode, see your online *User's Guide*.

See "System Lights" on page 49 for a description of light codes that can help you troubleshoot problems with your computer.
- 5 power button      Press this button to turn on the computer.
  - ➔ **NOTICE:** To avoid losing data, do not turn off the computer by pressing the power button. Instead, perform an operating system shutdown. See "Before You Begin" on page 25 for more information.
- 6 vents              The vents help prevent your computer from overheating. To ensure proper ventilation, do not block these cooling vents.
- 7 module bay        Install a D-module optical drive, second hard drive, or floppy drive in the module bay.
- 8 hard-drive access light      The hard-drive access light is on when the computer reads data from or writes data to the hard drive. The light might also be on when devices such as your CD player are operating.
- 9 vents              The vents help prevent your computer from overheating. To ensure proper ventilation, do not block these cooling vents.

### Ultra-Small Form Factor Computer — Side View

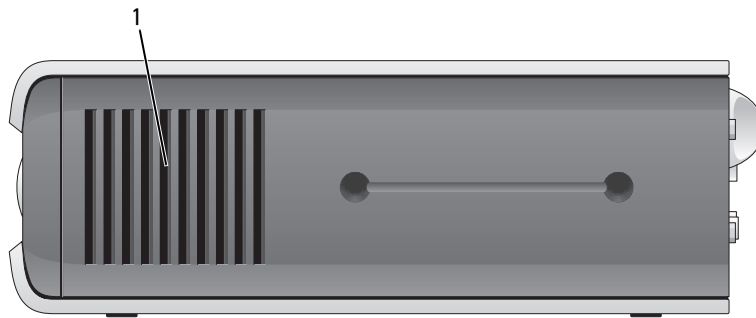

- 1 vents              The vents located on each side of the computer help prevent your computer from overheating. To ensure proper ventilation, do not block these cooling vents.

## Ultra-Small Form Factor Computer — Back View

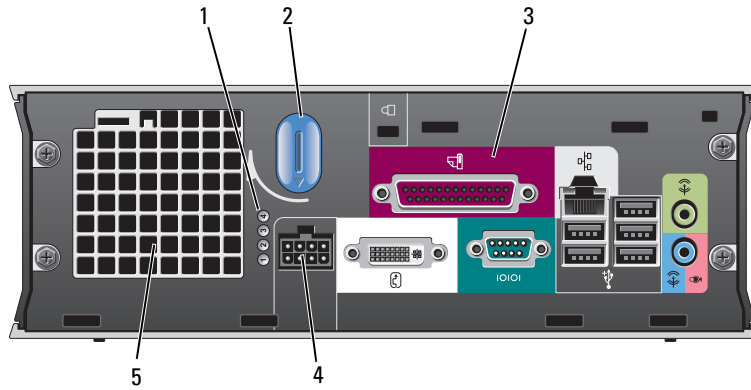

- |   |                             |   |
|---|-----------------------------|---|
| 1 | diagnostic lights           | See "Diagnostic Lights" on page 50 for a description of light codes that can help you troubleshoot problems with your computer. |
| 2 | computer cover release knob | Rotate this knob in a clockwise direction to remove the cover.  |
| 3 | back-panel connectors       | The connectors for your computer (see "Ultra-Small Form Factor Computer — Back-Panel Connectors" on page 23).                   |
| 4 | power connector             | Insert the power cable.   |
| 5 | vents                       | The vents help prevent your computer from overheating. To ensure proper ventilation, do not block these cooling vents.          |

## Ultra-Small Form Factor Computer — Back-Panel Connectors

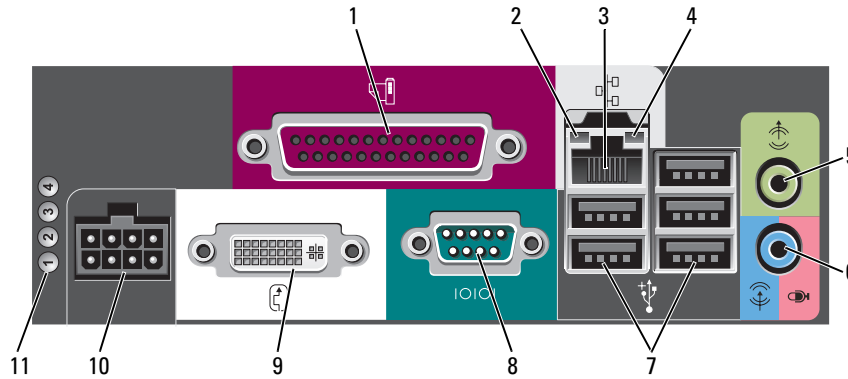

- |   |                    |   |
|---|--------------------|---|
| 1 | parallel connector | Connect a parallel device, such as a printer, to the parallel connector. If you have a USB printer, plug it into a USB connector. |
|---|--------------------|---|

- |    |                               |   |
|----|-------------------------------|---|
| 2  | link integrity light          | <ul style="list-style-type: none"> <li>• Green — A good connection exists between a 10-Mbps network and the computer.</li> <li>• Orange — A good connection exists between a 100-Mbps network and the computer.</li> <li>• Yellow — A good connection exists between a 1000-Mbps (1-Gbps) network and the computer.</li> <li>• Off — The computer is not detecting a physical connection to the network or the network controller is turned off in system setup.</li> </ul>   |
| 3  | network adapter               | <p>To attach your computer to a network or broadband device, connect one end of a network cable to either a network jack or your network or broadband device. Connect the other end of the network cable to the network adapter connector on the back panel of your computer. A click indicates that the network cable has been securely attached.</p> <p><b>NOTE:</b> Do not plug a telephone cable into the network connector.</p> <p>On computers with a network connector card, use the connector on the card.</p> <p>It is recommended that you use Category 5 wiring and connectors for your network. If you must use Category 3 wiring, force the network speed to 10 Mbps to ensure reliable operation.</p> |
| 4  | network activity light        | The amber light flashes when the computer is transmitting or receiving network data. A high volume of network traffic may make this light appear to be in a steady "on" state.  |
| 5  | line-out connector            | Use the green line-out connector to attach an amplified speaker set.  |
| 6  | line-in/ microphone connector | Use the blue and pink line-in/ microphone connector to attach a record/playback device such as a cassette player, CD player, or VCR.; or a personal computer microphone for voice or musical input into a sound or telephony program.   |
| 7  | USB connectors (5)            | Use the back USB connectors for devices that typically remain connected, such as printers and keyboards.  |
| 8  | serial connector              | Connect a serial device, such as a handheld device, to the serial connector.  |
| 9  | video connector               | <p>If you have a DVI-compatible monitor, plug the cable from your monitor into the white connector on the back panel.</p> <p>If you have a VGA monitor, see "Connecting a VGA Monitor" in your computer <i>User's Guide</i>.</p>  |
| 10 | power connector               | The connector for the power adapter.  |
| 11 | diagnostic lights             | See "Diagnostic Lights" on page 50 for a description of light codes that can help you troubleshoot problems with your computer.   |

## Removing the Computer Cover



**CAUTION:** Before you begin any of the procedures in this section, follow the safety instructions in the *Product Information Guide*.



**CAUTION:** To guard against electrical shock, always unplug your computer from the electrical outlet before removing the cover.



## Before You Begin

- ➔ **NOTICE:** To avoid losing data, save and close any open files and exit any open programs before you turn off your computer.
- 1 Shut down the operating system:
  - a Save and close any open files, exit any open programs, click the **Start** button, and then click **Turn Off Computer**.
  - b In the **Turn off computer** window, click **Turn off**.  
The computer turns off after the operating system shutdown process finishes.
- 2 Ensure that the computer and any attached devices are turned off. If your computer and attached devices did not automatically turn off when you shut down your operating system, turn them off now.

## Before Working Inside Your Computer

Use the following safety guidelines to help protect your computer from potential damage and to help ensure your own personal safety.

- ⚠ **CAUTION:** Before you begin any of the procedures in this section, follow the safety instructions in the *Product Information Guide*.
- ⚠ **CAUTION:** Handle components and cards with care. Do not touch the components or contacts on a card. Hold a card by its edges or by its metal mounting bracket. Hold a component such as a processor by its edges, not by its pins.
- ➔ **NOTICE:** Only a certified service technician should perform repairs on your computer. Damage due to servicing that is not authorized by Dell is not covered by your warranty.
- ➔ **NOTICE:** When you disconnect a cable, pull on its connector or on its strain-relief loop, not on the cable itself. Some cables have a connector with locking tabs; if you are disconnecting this type of cable, press in on the locking tabs before you disconnect the cable. As you pull connectors apart, keep them evenly aligned to avoid bending any connector pins. Also, before you connect a cable, ensure that both connectors are correctly oriented and aligned.

To avoid damaging the computer, perform the following steps before you begin working inside the computer.

- 1 Turn off your computer.
  - ➔ **NOTICE:** To disconnect a network cable, first unplug the cable from your computer and then unplug it from the network wall jack.
  - 2 Disconnect any telephone or telecommunication lines from the computer.
  - 3 Disconnect your computer and all attached devices from their electrical outlets, and then press the power button to ground the system board.
  - 4 If applicable, remove the computer stand (for instructions, see the documentation that came with the stand).
- ⚠ **CAUTION:** To guard against electrical shock, always unplug your computer from the electrical outlet before removing the cover.

**5** Remove the computer cover:

- Remove the mini tower computer cover (see "Mini Tower Computer" on page 26).
- Remove the desktop computer cover (see "Desktop Computer" on page 27).
- Remove the small form factor computer cover (see "Small Form Factor Computer" on page 28).
- Remove the ultra-small form factor computer cover (see "Ultra-Small Form Factor Computer" on page 30).

 **NOTICE:** Before touching anything inside your computer, ground yourself by touching an unpainted metal surface, such as the metal at the back of the computer. While you work, periodically touch an unpainted metal surface to dissipate any static electricity that could harm internal components.

### Mini Tower Computer

 **CAUTION:** Before you begin any of the procedures in this section, follow the safety instructions in the *Product Information Guide*.

 **CAUTION:** To guard against electrical shock, always unplug your computer from the electrical outlet before removing the computer cover.

- 1 Follow the procedures in "Before You Begin" on page 25.
- 2 Lay the computer on its side as shown in the illustration.
- 3 Locate the cover release latch shown in the illustration. Then, slide the release latch back as you lift the cover.
- 4 Grip the sides of the computer cover and pivot the cover up using the hinge tabs as leverage points.
- 5 Remove the cover from the hinge tabs and set it aside on a soft nonabrasive surface.

 **CAUTION:** Graphic card heatsinks may become very hot during normal operation. Ensure that a graphic card heatsink has had sufficient time to cool before you touch it.

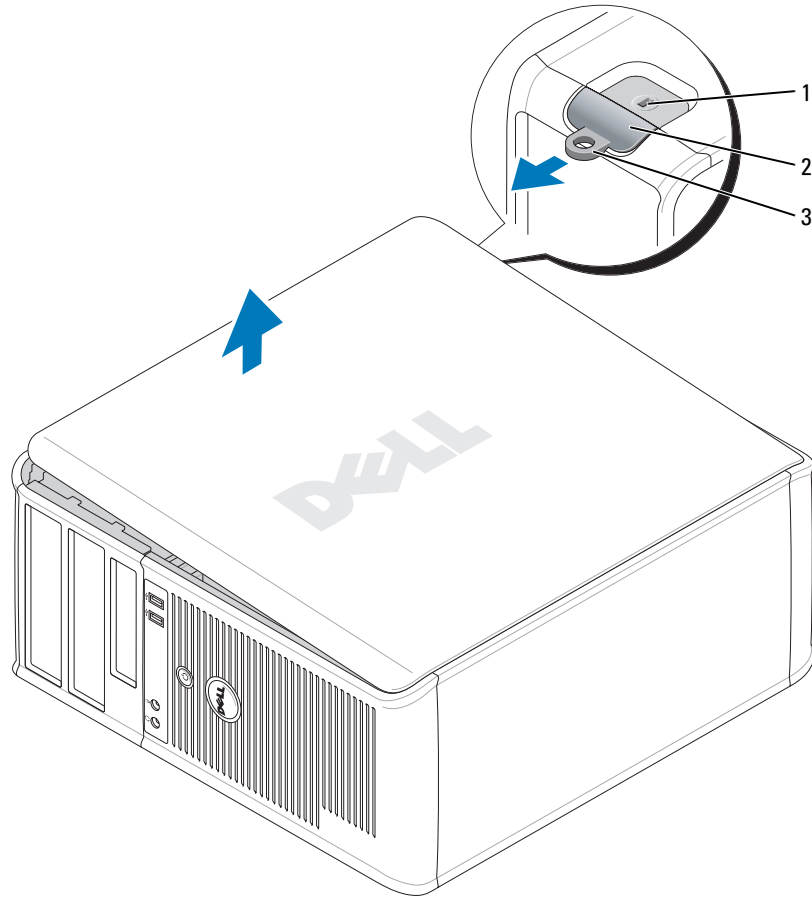

1 security cable slot

2 cover release latch

3 padlock ring

### Desktop Computer



**CAUTION:** Before you begin any of the procedures in this section, follow the safety instructions in the *Product Information Guide*.



**CAUTION:** To guard against electrical shock, always unplug your computer from the electrical outlet before removing the computer cover.

- 1 Follow the procedures in "Before You Begin" on page 25.
- 2 If you have installed a padlock through the padlock ring on the back panel, remove the padlock.

- 3 Locate the cover release latch shown in the illustration. Then, slide the release latch back as you lift the cover.
- 4 Grip the sides of the computer cover and pivot the cover up using the hinge tabs as leverage points.
- 5 Remove the cover from the hinge tabs and set it aside on a soft nonabrasive surface.

**CAUTION:** Graphic card heatsinks may become very hot during normal operation. Ensure that a graphic card heatsink has had sufficient time to cool before you touch it.

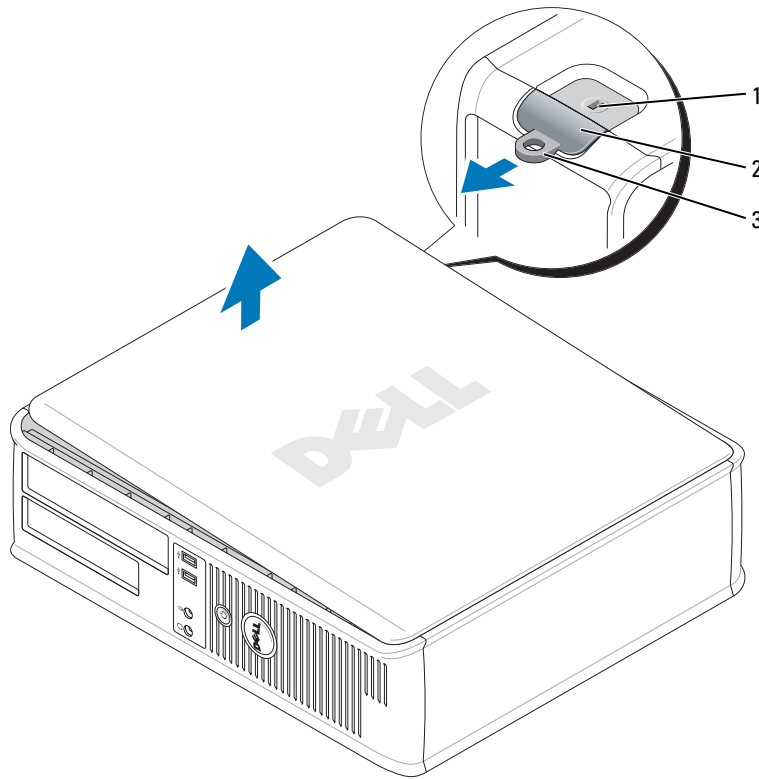

1 security cable slot

2 cover release latch

3 padlock ring

### Small Form Factor Computer

**CAUTION:** Before you begin any of the procedures in this section, follow the safety instructions in the *Product Information Guide*.

**CAUTION:** To guard against electrical shock, always unplug your computer from the electrical outlet before removing the computer cover.

- 1 Follow the procedures in "Before You Begin" on page 25.
- 2 If you have installed a padlock through the padlock ring on the back panel, remove the padlock.
- 3 Locate the cover release latch shown in the illustration. Then, slide the release latch back as you lift the cover.
- 4 Grip the sides of the computer cover and pivot the cover up using the bottom hinges as leverage points.
- 5 Remove the cover from the hinge tabs and set it aside on a soft nonabrasive surface.

**⚠ CAUTION: Graphic card heatsinks may become very hot during normal operation. Ensure that a graphic card heatsink has had sufficient time to cool before you touch it.**

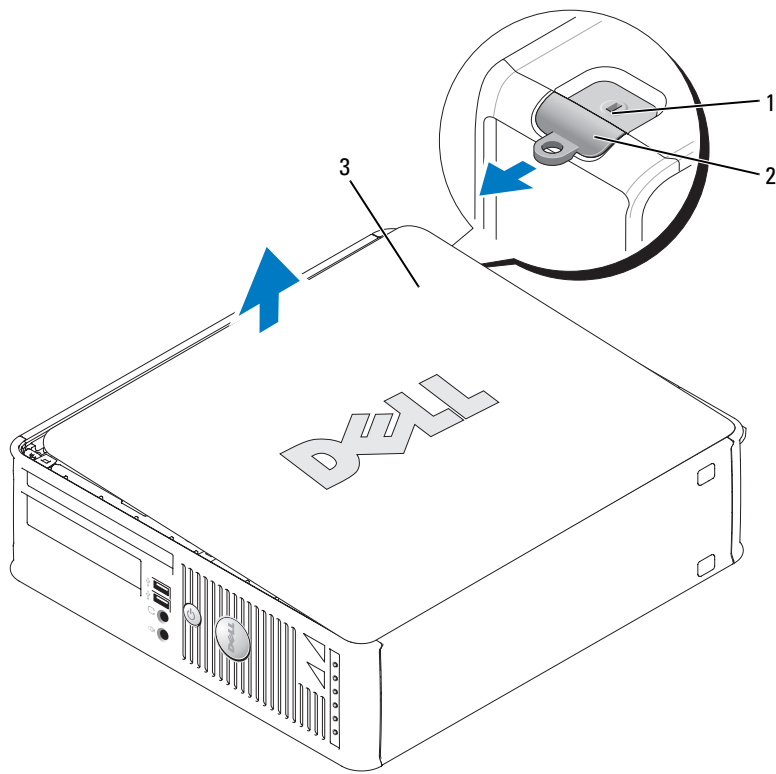

1 security cable slot

2 cover release latch

3 computer cover

## Ultra-Small Form Factor Computer

**!** **CAUTION:** Before you begin any of the procedures in this section, follow the safety instructions in the *Product Information Guide*.

**!** **CAUTION:** To guard against electrical shock, always unplug your computer from the electrical outlet before removing the computer cover.

1 Follow the procedures in "Before You Begin" on page 25.

**➔** **NOTICE:** Before touching anything inside your computer, ground yourself by touching an unpainted metal surface. While you work, periodically touch an unpainted metal surface to dissipate any static electricity that could harm internal components.

2 If applicable, remove the cable cover.

a If a security device is installed in the security cable slot, remove the device.

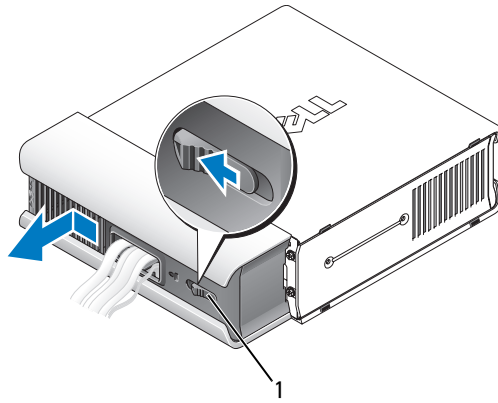

1 release button

b Press on the release button, grasp the cable cover, and slide the cover to the left until it stops, and then lift the cable cover up and away.

3 Remove the computer cover:

a Rotate the cover release knob in a clockwise direction, as shown in the illustration.

b Slide the computer cover forward by 1 cm (1/2 inch), or until it stops, and then raise the cover.

**CAUTION:** Graphic card heatsinks may become very hot during normal operation. Ensure that a graphic card heatsink has had sufficient time to cool before you touch it.

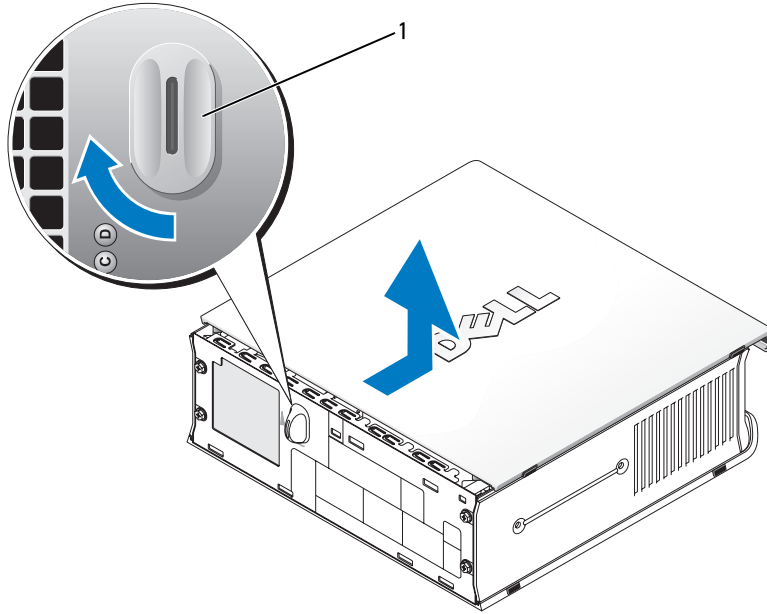

1 release knob

# Inside Your Computer

## Mini Tower Computer

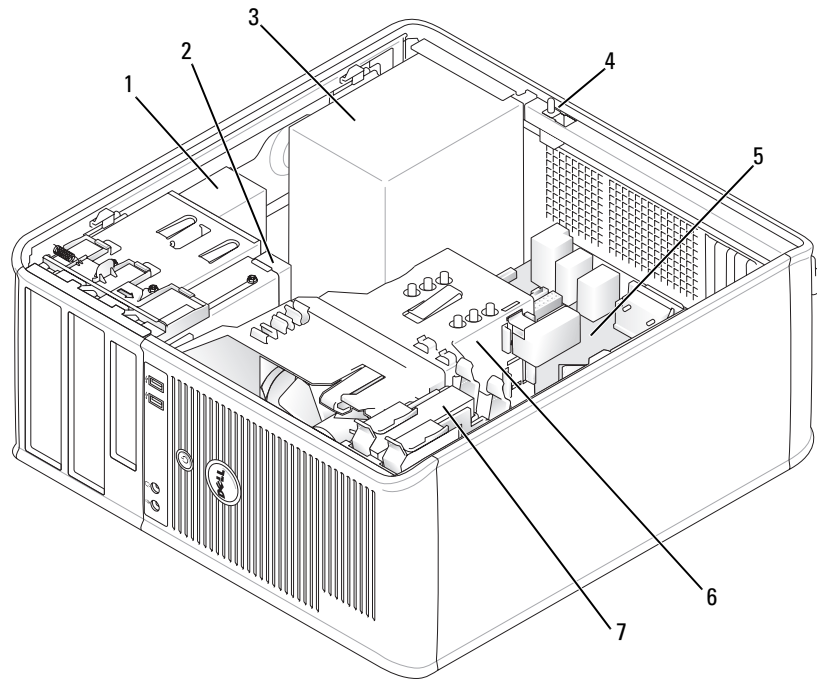

- |   |                                   |   |                                   |   |                    |
|---|-----------------------------------|---|-----------------------------------|---|--------------------|
| 1 | optical drive                     | 2 | floppy drive or media card reader | 3 | power supply       |
| 4 | optional chassis-intrusion switch | 5 | system board                      | 6 | heat-sink assembly |
| 7 | hard drive                        |   |                                   |   |                    |





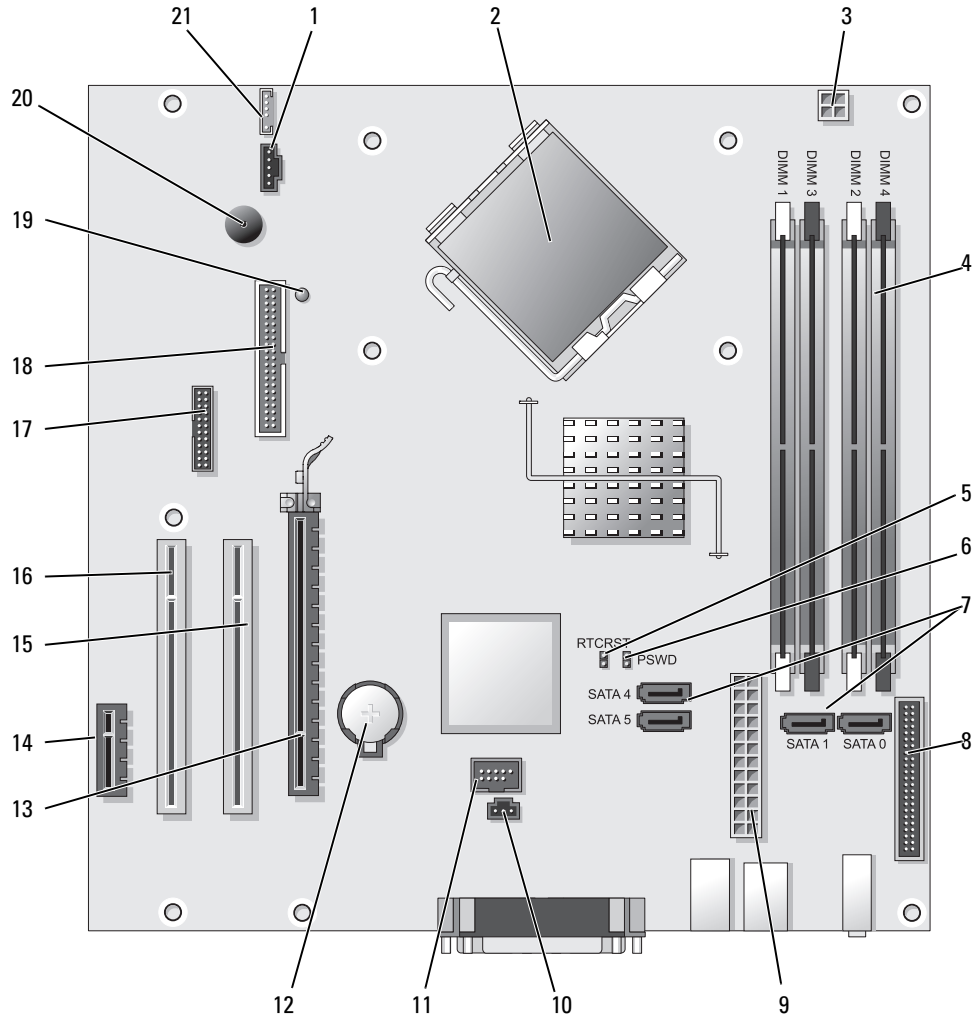

### System Board Components



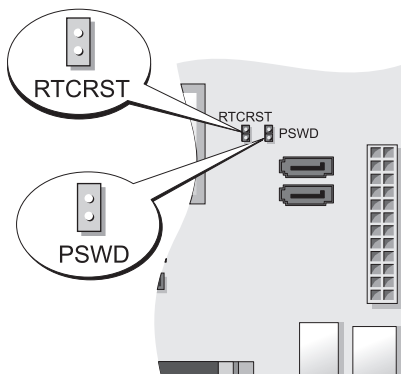

- |    |   |    |                                   |
|----|---|----|-----------------------------------|
| 1  | fan connector (FAN)                                       | 12 | battery socket (BATT)             |
| 2  | processor connector (CPU)                                 | 13 | PCI Express x16 connector (SLOT1) |
| 3  | processor power connector (12VPOWER)                      | 14 | PCI Express x1 connector (SLOT4)  |
| 4  | memory module connectors (DIMM_1, DIMM_2, DIMM_3, DIMM_4) | 15 | PCI connector (SLOT2)             |
| 5  | RTC reset jumper (RTCRST)                                 | 16 | PCI connector (SLOT3)             |
| 6  | password jumper (PSWD)                                    | 17 | serial connector (SER2)           |
| 7  | SATA drive connectors (SATA0, SATA1, SATA4, SATA5)        | 18 | floppy drive connector (DSKT)     |
| 8  | front-panel connector (FNT_PANEL)                         | 19 | flea power                        |
| 9  | power connector (POWER)                                   | 20 | system board speaker (BEEP)       |
| 10 | intrusion switch connector (INTRUDER)                     | 21 | speaker connector (INT_SPKR)      |
| 11 | internal USB (INTERNAL_USB)                               |    |                                   |

### Jumper Settings



Jumper	Setting	Description
PSWD		Password features are enabled (default setting).
		Password features are disabled.
RTC RST		The real-time clock has not been reset.
		The real-time clock is being reset (jumped temporarily).

 *jumped*   
  *unjumpered*

### Desktop Computer

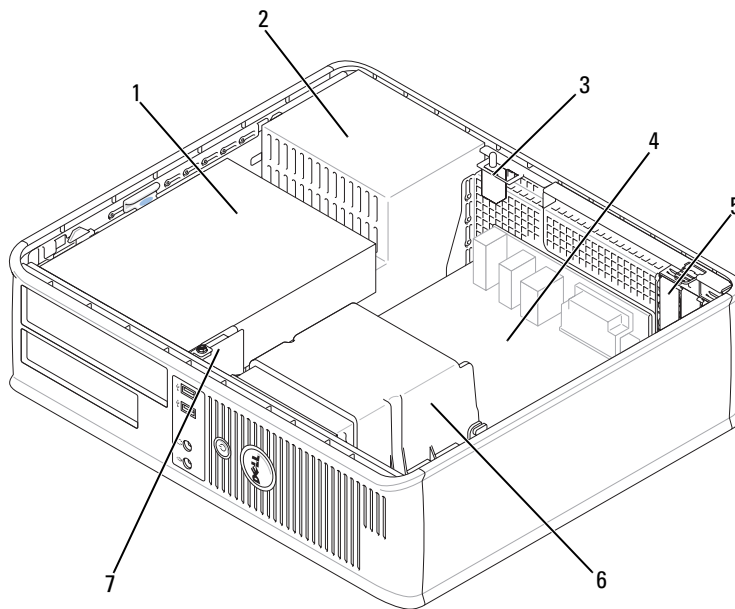

- |   |  |   |              |   |                                   |
|---|--|---|--------------|---|-----------------------------------|
| 1 | drive bays (media card reader or floppy drive, optical drive and hard drive) | 2 | power supply | 3 | optional chassis-intrusion switch |
| 4 | system board   | 5 | card slots   | 6 | heat sink assembly                |
| 7 | front I/O panel  |   |              |   |                                   |

### System Board Components

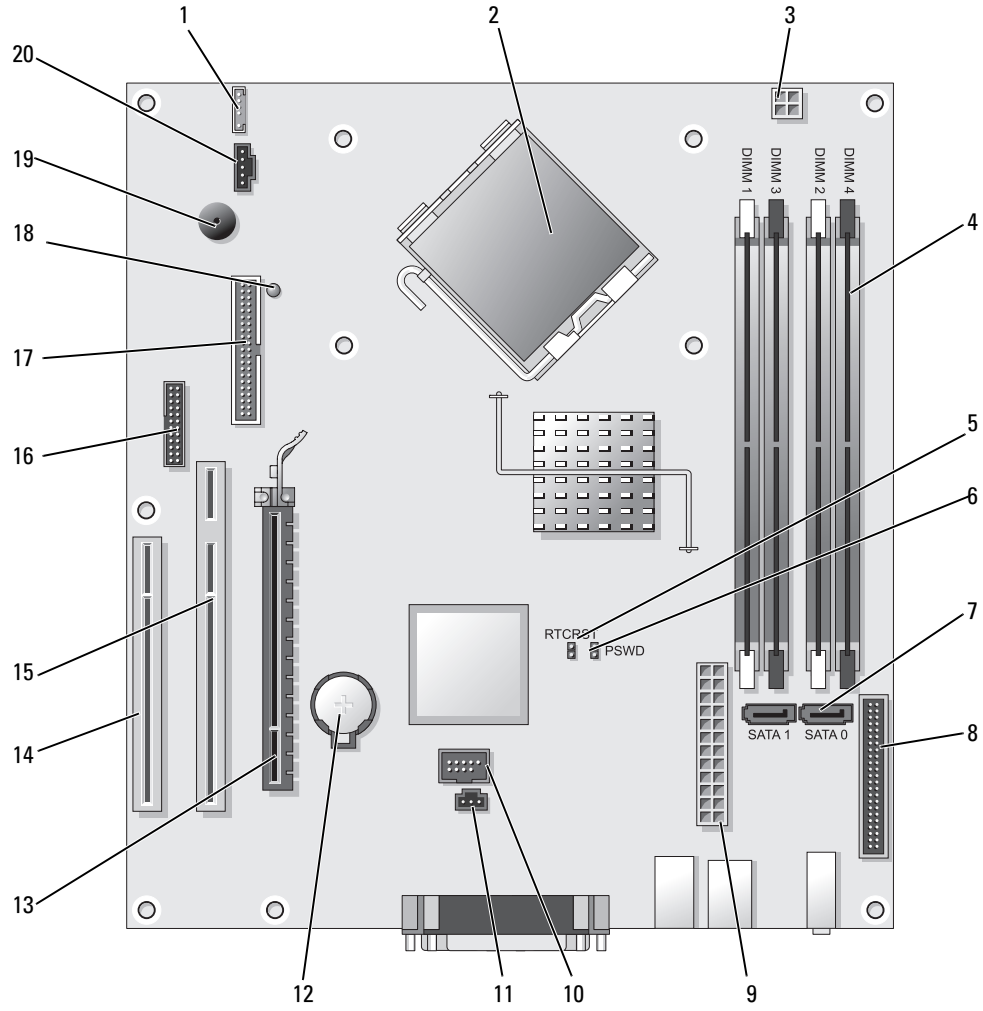

- |    |   |    |                                       |
|----|---|----|---------------------------------------|
| 1  | internal speaker (INT_SPKR)                               | 11 | intrusion switch connector (INTRUDER) |
| 2  | processor connector (CPU)                                 | 12 | battery socket (BATT)                 |
| 3  | processor power connector (12VPOWER)                      | 13 | PCI Express x16 connector (SLOT1)     |
| 4  | memory module connectors (DIMM_1, DIMM_2, DIMM_3, DIMM_4) | 14 | PCI connector (SLOT3)                 |
| 5  | RTC reset jumper (RTCRST)                                 | 15 | PCI connector (SLOT2)                 |
| 6  | password jumper (PSWD)                                    | 16 | serial connector (SER2)               |
| 7  | SATA connectors (SATA0, SATA1)                            | 17 | floppy drive connector (DSKT)         |
| 8  | front-panel connector (FNT_PANEL)                         | 18 | flea power                            |
| 9  | power connector (POWER)                                   | 19 | system board speaker (BEEP)           |
| 10 | internal USB (INTERNAL_USB)                               | 20 | fan connector (FAN)                   |

**Jumper Settings**

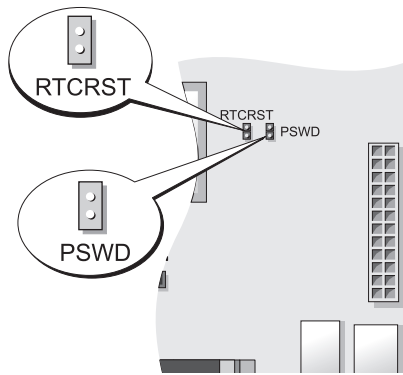

Jumper	Setting	Description
PSWD		Password features are enabled (default setting).
		Password features are disabled.
RTCRST		The real-time clock has not been reset.
		The real-time clock is being reset (jumpered temporarily).

*jumpered*    *unjumpered*

## Small Form Factor Computer

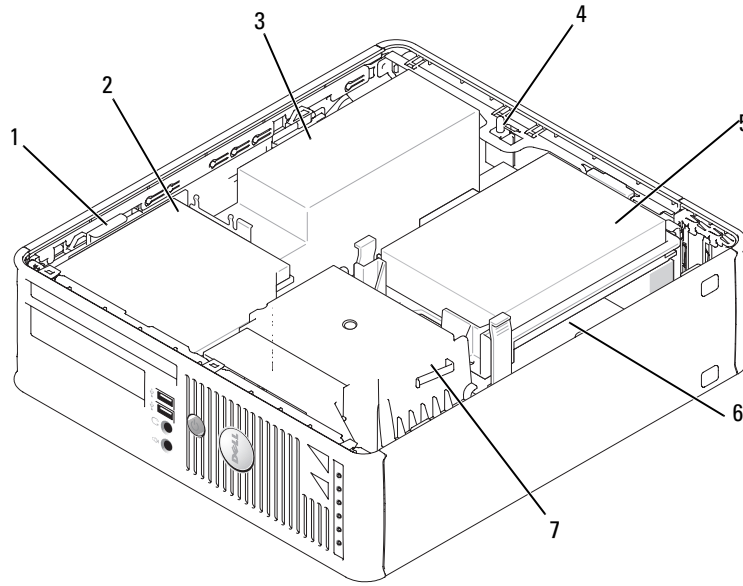

- |   |                                   |   |               |   |                      |
|---|-----------------------------------|---|---------------|---|----------------------|
| 1 | drive-release latch               | 2 | optical drive | 3 | power supply and fan |
| 4 | optional chassis-intrusion switch | 5 | hard drive    | 6 | system board         |
| 7 | heat sink and blower assembly     |   |               |   |                      |

### System Board Components

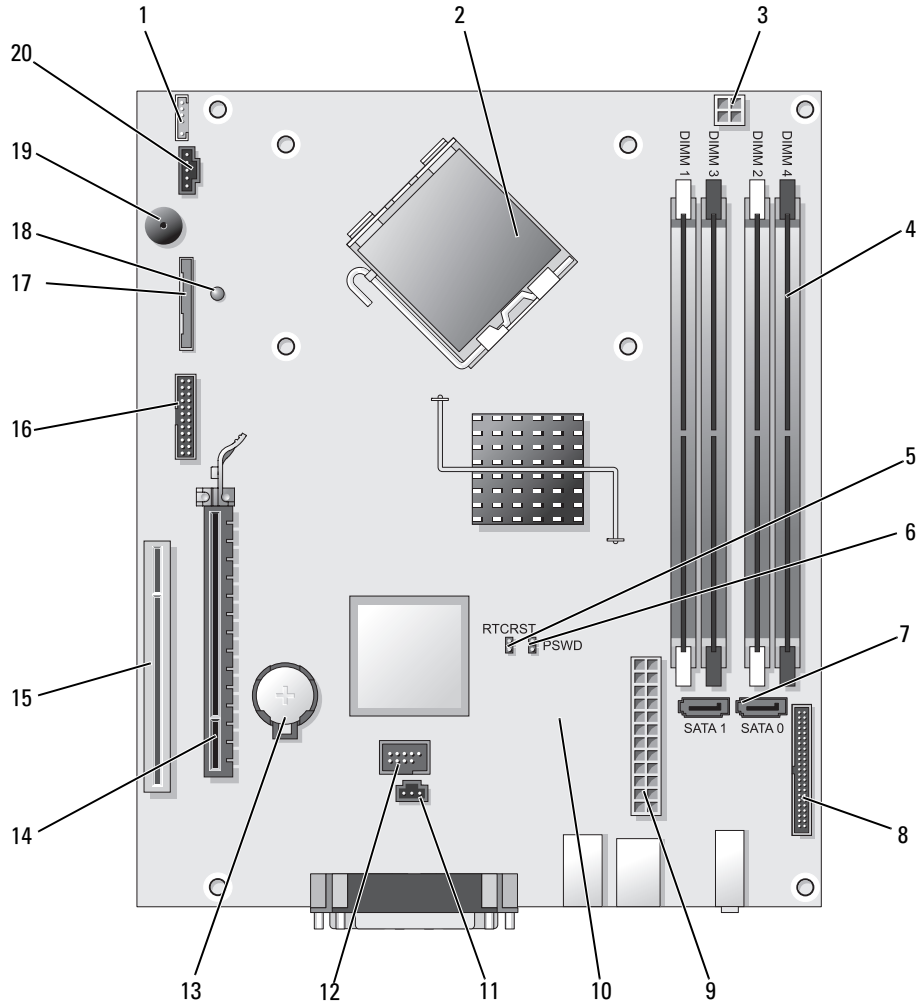





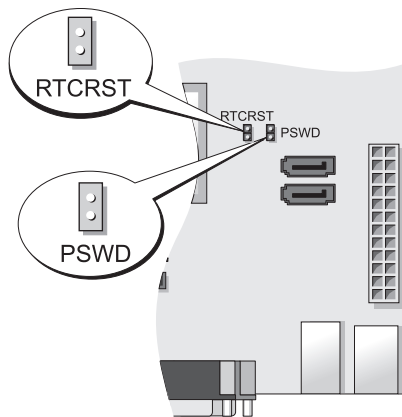

- |    |   |    |                                       |
|----|---|----|---------------------------------------|
| 1  | internal speaker connector (INT_SPKR)                     | 11 | intrusion switch connector (INTRUDER) |
| 2  | processor connector (CPU)                                 | 12 | internal USB connector (USB)          |
| 3  | processor power connector (12VPOWER)                      | 13 | battery socket (BATT)                 |
| 4  | memory module connectors (DIMM_1, DIMM_2, DIMM_3, DIMM_4) | 14 | PCI Express x16 connector (SLOT1)     |
| 5  | RTC reset jumper (RTCRST)                                 | 15 | PCI connector (SLOT2)                 |
| 6  | password jumper (PSWD)                                    | 16 | serial connector (SER2)               |
| 7  | SATA connectors (SATA0, SATA1)                            | 17 | floppy drive connector (DSKT)         |
| 8  | front-panel connector (FNT_PANEL)                         | 18 | flea power                            |
| 9  | power connector (POWER)                                   | 19 | system board speaker (BEEP)           |
| 10 | fan connector (FAN2)                                      | 20 | fan connector (FAN)                   |

### Jumper Settings





Jumper	Setting	Description
PSWD		Password features are enabled (default setting).
		Password features are disabled.
RTC RST		The real-time clock has not been reset.
		The real-time clock is being reset (jumped temporarily).

 *jumped*   
  *unjumpered*

### Ultra-Small Form Factor Computer

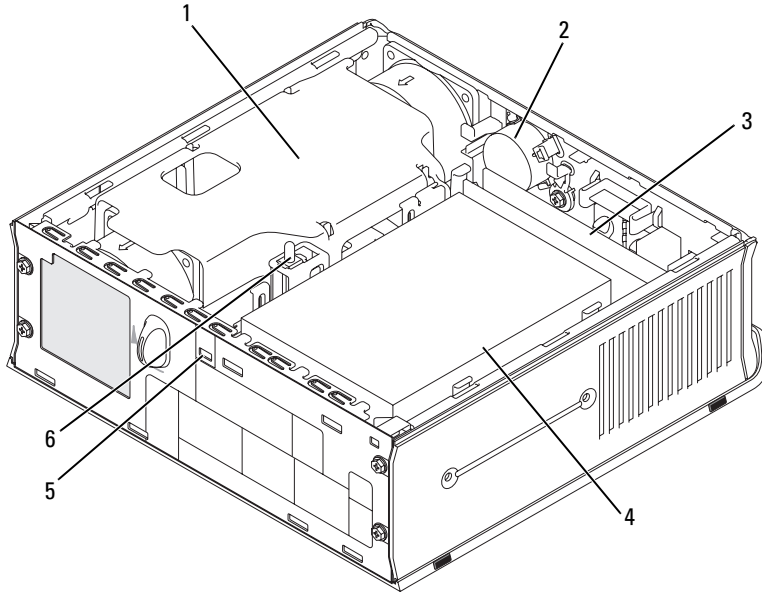

- |   |                                |   |                     |   |                          |
|---|--------------------------------|---|---------------------|---|--------------------------|
| 1 | fan shroud/ heat sink assembly | 2 | speaker (optional)  | 3 | memory modules (2)       |
| 4 | hard drive                     | 5 | security cable slot | 6 | chassis intrusion switch |



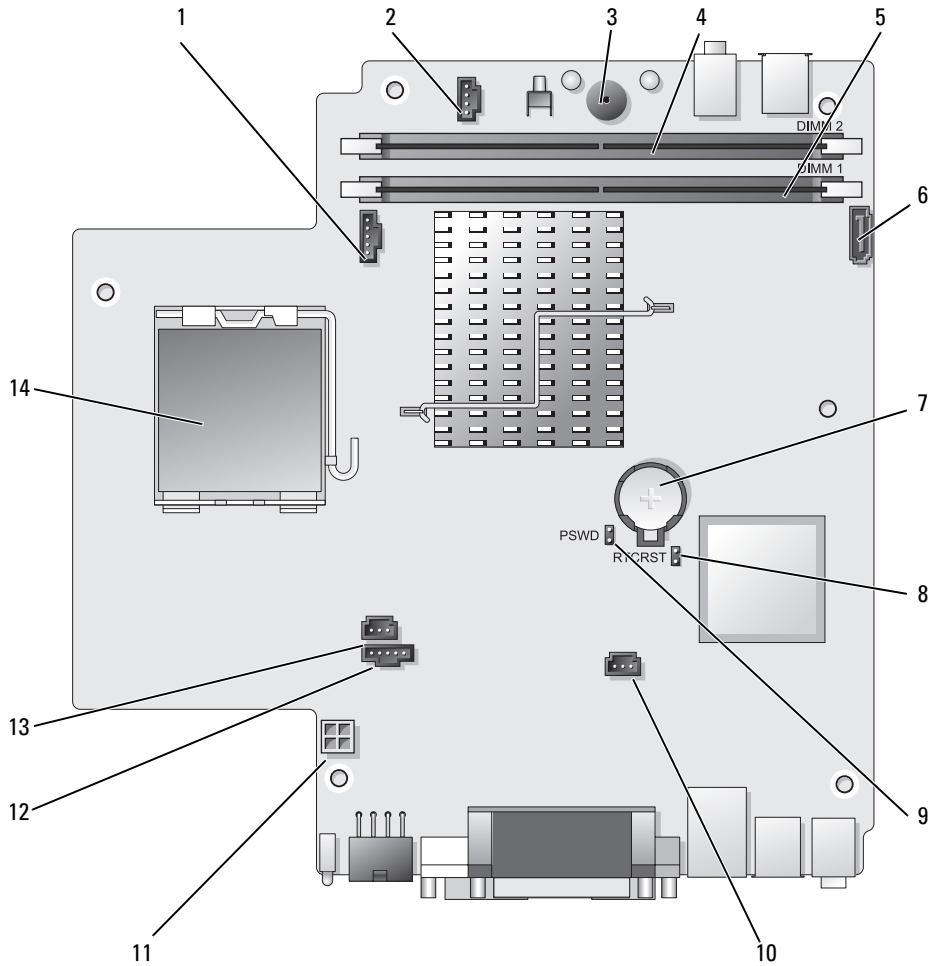

### System Board Components



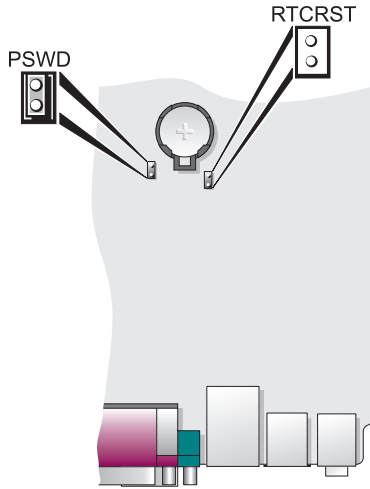

- |   |  |
|---|--|
| 1 fan connector (FAN_FRONT)             | 8 clear CMOS jumper (RTCRST)             |
| 2 internal speaker connector (INT_SPKR) | 9 password jumper (PSWD)                 |
| 3 system board speaker (BEEP)           | 10 hard-drive fan connector (FAN_HDD)    |
| 4 channel B memory connector (DIMM_2)   | 11 hard-drive power connector (SATA_PWR) |
| 5 channel A memory connector (DIMM_1)   | 12 fan connector (FAN_REAR)              |
| 6 SATA data cable connector(SATA0)      | 13 intrusion switch connector (INTRUDER) |
| 7 battery (BATT)                        | 14 processor (CPU)                       |



## Jumper Settings



Jumper	Setting	Description
PSWD		Password features are enabled (default setting).
		Password features are disabled.
RTCRST		The real-time clock has not been reset.
		The real-time clock is being reset (jumpered temporarily).

 *jumpered*   
  *unjumpered*

## Setting Up Your Computer

-  **CAUTION:** Before performing any of the procedures in this section, follow the safety instructions in *Product Information Guide*.
-  **NOTICE:** If your computer has an expansion card installed (such as a modem card), connect the appropriate cable to the card, *not* to the connector on the back panel.
-  **NOTICE:** To help allow the computer to maintain proper operating temperature, ensure that you do not place the computer too close to a wall or other storage compartment that might prevent air circulation around the chassis. See your Product Information Guide for more information.

 **NOTE:** Before you install any devices or software that did not ship with your computer, read the documentation that came with the device or software, or contact the vendor to verify that the device or software is compatible with your computer and operating system.

You must complete all the steps to properly set up your computer. See the appropriate figures that follow the instructions.

 **NOTICE:** Do not attempt to operate a PS/2 mouse and a USB mouse simultaneously.

1 Connect the keyboard and mouse.

 **NOTICE:** Do not connect a modem cable to the network adapter connector. Voltage from telephone communications can cause damage to the network adapter

2 Connect the modem or network cable.

Insert the network cable, not the telephone line, into the network connector. If you have an optional modem, connect the telephone line to the modem.

3 Connect the monitor.

Align and gently insert the monitor cable to avoid bending connector pins. Tighten the thumbscrews on the cable connectors.

 **NOTE:** Some monitors have the video connector underneath the back of the screen. See the documentation that came with your monitor for its connector locations.

4 Connect the speakers.

5 Connect power cables to the computer, monitor, and devices and connect the other ends of the power cables to electrical outlets.

 **NOTICE:** To avoid damaging a computer with a manual voltage-selection switch, set the switch for the voltage that most closely matches the AC power available in your location.

 **NOTICE:** In Japan, the voltage selection switch must be set to the 115-V position even though the AC power available in Japan is 100 V.

6 Verify that the voltage selection switch is set correctly for your location.

Your computer has a manual voltage-selection switch. Computers with a voltage selection switch on the back panel must be manually set to operate at the correct operating voltage.

## Set Up Your Keyboard and Mouse

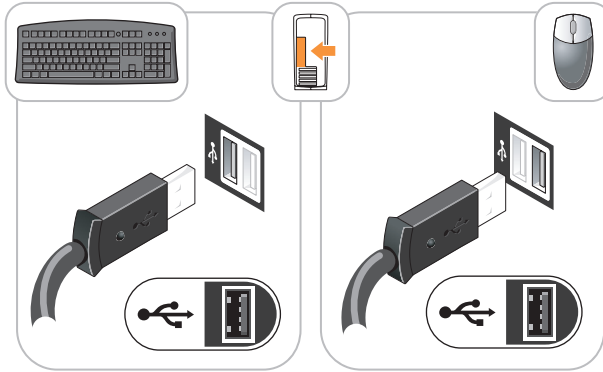

## Set Up Your Monitor

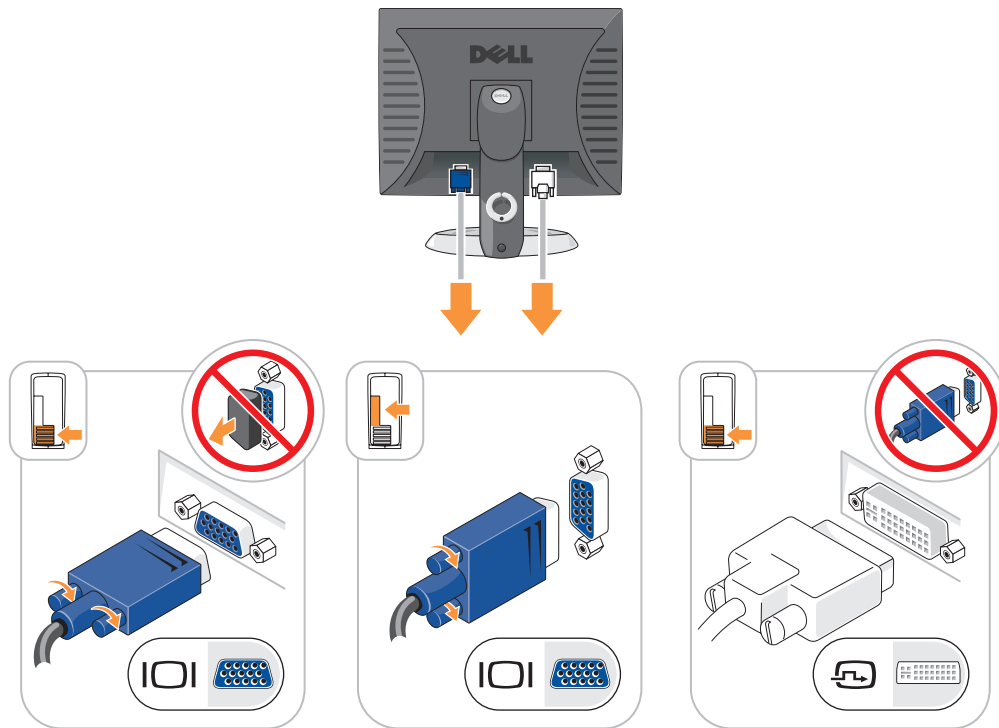

## Power Connections

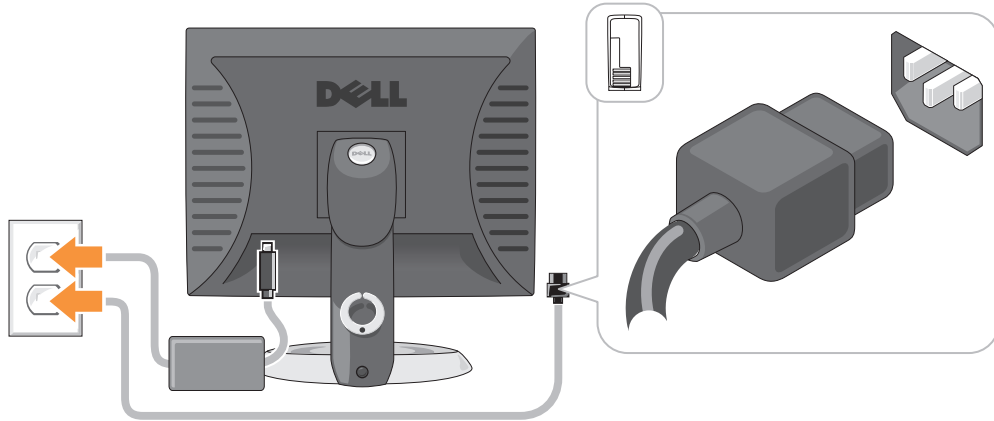

## Solving Problems

Dell provides a number of tools to help you if your computer does not perform as expected. For the latest troubleshooting information available for your computer, see the Dell Support website at [support.dell.com](http://support.dell.com).

If computer problems occur that require help from Dell, write a detailed description of the error, beep codes, or diagnostics light patterns, record your Express Service Code and Service Tag below, and then contact Dell from the same location as your computer. For information on contacting Dell, see your online *User's Guide*.

For an example of the Express Service Code and Service Tag, see "Finding Information" in your computer *User's Guide*.

Express Service Code: \_\_\_\_\_

Service Tag: \_\_\_\_\_

### Dell Diagnostics

**⚠ CAUTION:** Before you begin any of the procedures in this section, follow the safety instructions in the *Product Information Guide*.

#### When to Use the Dell Diagnostics

If you experience a problem with your computer, perform the checks in "Solving Problems" in your online *User's Guide* and run the Dell Diagnostics before you contact Dell for technical assistance. For information on contacting Dell, see your online *User's Guide*.

**➡ NOTICE:** The Dell Diagnostics works only on Dell™ computers.

Enter system setup (see "System Setup" in your online *User's Guide* for instructions), review your computer's configuration information, and ensure that the device you want to test displays in system setup and is active.

Start the Dell Diagnostics from either your hard drive or from the optional *Drivers and Utilities CD (ResourceCD)*.

### Starting the Dell Diagnostics From Your Hard Drive

- 1 Turn on (or restart) your computer.
- 2 When the DELL logo appears, press <F12> immediately.

 **NOTE:** If you see a message stating that no diagnostics utility partition has been found, run the Dell Diagnostics from the optional *Drivers and Utilities CD* (see "Starting the Dell Diagnostics From the Drivers and Utilities CD" on page 47).

If you wait too long and the operating system logo appears, continue to wait until you see the Microsoft® Windows® desktop. Then shut down your computer and try again.

When the boot device list appears, highlight **Boot to Utility Partition** and press <Enter>.

- 3 When the Dell Diagnostics **Main Menu** appears, select the test you want to run.

### Starting the Dell Diagnostics From the Drivers and Utilities CD

- 1 Insert the *Drivers and Utilities CD*.
- 2 Shut down and restart the computer.

When the DELL logo appears, press <F12> immediately.

If you wait too long and the operating system logo appears, continue to wait until you see the Microsoft Windows desktop. Then shut down your computer and try again.

 **NOTE:** The next steps change the boot sequence for one time only. On the next start-up, the computer boots according to the devices specified in system setup.

- 3 When the boot device list appears, highlight the listing for the CD/DVD drive and press <Enter>.
- 4 Select the listing for the CD/DVD drive option from the CD boot menu.
- 5 Select the option to boot from the CD/DVD drive from the menu that appears.
- 6 Type 1 to start the *Drivers and Utilities CD* menu.
- 7 Type 2 to start the Dell Diagnostics.
- 8 Select **Run the 32 Bit Dell Diagnostics** from the numbered list. If multiple versions are listed, select the version appropriate for your computer.
- 9 When the Dell Diagnostics **Main Menu** appears, select the test you want to run.

### Dell Diagnostics Main Menu

- 1 After the Dell Diagnostics loads and the **Main Menu** screen appears, click the button for the option you want.

Option	Function
Express Test	Performs a quick test of devices. This test typically takes 10 to 20 minutes and requires no interaction on your part. Run <b>Express Test</b> first to increase the possibility of tracing the problem quickly.
Extended Test	Performs a thorough check of devices. This test typically takes an hour or more and requires you to answer questions periodically.
Custom Test	Tests a specific device. You can customize the tests you want to run.
Symptom Tree	Lists the most common symptoms encountered and allows you to select a test based on the symptom of the problem you are having.

- 2 If a problem is encountered during a test, a message appears with an error code and a description of the problem. Write down the error code and problem description and follow the instructions on the screen.

If you cannot resolve the error condition, contact Dell. For information on contacting Dell, see your online *User's Guide*.

 **NOTE:** The Service Tag for your computer is located at the top of each test screen. If you contact Dell, technical support will ask for your Service Tag.

- 3 If you run a test from the **Custom Test** or **Symptom Tree** option, click the applicable tab described in the following table for more information.

Tab	Function
Results	Displays the results of the test and any error conditions encountered.
Errors	Displays error conditions encountered, error codes, and the problem description.
Help	Describes the test and may indicate requirements for running the test.
Configuration	Displays your hardware configuration for the selected device.  The Dell Diagnostics obtains configuration information for all devices from system setup, memory, and various internal tests, and it displays the information in the device list in the left pane of the screen. The device list may not display the names of all the components installed on your computer or all devices attached to your computer.
Parameters	You can customize the test by changing the test settings.



- 4 When the tests are completed, if you are running the Dell Diagnostics from the *Drivers and Utilities* CD (optional), remove the CD.
- 5 Close the test screen to return to the **Main Menu** screen. To exit the Dell Diagnostics and restart the computer, close the **Main Menu** screen.

## System Lights

Your power light may indicate a computer problem.

Power Light	Problem Description	Suggested Resolution
Solid green	Power is on, and the computer is operating normally.	No corrective action is required.
Blinking green	The computer is in a power-saving mode.	Press the power button, move the mouse, or press a key on the keyboard to wake the computer.
Blinks green several times and then turns off	A configuration error exists.	Check Diagnostic Lights to see if the specific problem is identified (see "Diagnostic Lights" on page 50).
Solid yellow	A device on the system board may be faulty or incorrectly installed or the voltage selection switch on the power supply may be set incorrectly.	Check Diagnostic Lights to see if the specific problem is identified (see "Diagnostic Lights" on page 50). See "Power Problems" in your online <i>User's Guide</i> . If the computer does not boot, contact Dell for technical assistance. For information on contacting Dell, see your online <i>User's Guide</i> .
Blinking yellow	A power supply or system board failure has occurred.	Check Diagnostic Lights to see if the specific problem is identified (see "Diagnostic Lights" on page 50). See "Power Problems" in your online <i>User's Guide</i> . If the computer does not boot, contact Dell for technical assistance. For information on contacting Dell, see your online <i>User's Guide</i> .
Solid green and a beep code during POST	A problem was detected while the BIOS was executing.	For instructions on diagnosing the beep code see "Beep Codes" on page 52. Also, check Diagnostic Lights to see if the specific problem is identified.

Power Light	Problem Description	Suggested Resolution
Solid green power light, no beep code and no video during POST	The monitor or the graphics card may be faulty or incorrectly installed.	Check Diagnostic Lights to see if the specific problem is identified.
Solid green power light and no beep code, but the computer locks up during POST	An integrated system board device may be faulty.	Check Diagnostic Lights to see if the specific problem is identified. If the problem is not identified, contact Dell for technical assistance. For information on contacting Dell, see your online <i>User's Guide</i> .

### Diagnostic Lights





**⚠ CAUTION:** Before you begin any of the procedures in this section, follow the safety instructions in the *Product Information Guide*.



To help you troubleshoot a problem, your computer has four lights labeled "1," "2," "3," and "4" on the front or back panel. The lights can be "off" or green. When the computer starts normally, the patterns or codes on the lights change as the boot process completes. If the POST portion of system boot completes successfully, all four lights display solid green for a short time, and then turn off.

If the computer malfunctions during the POST process, the pattern displayed on the LEDs may help identify where in the process the computer halted. If the computer malfunctions after a successful POST, the diagnostic lights do not indicate the cause of the problem.

**📌 NOTE:** The orientation of the diagnostic lights may vary depending on the system type. The diagnostic lights can be either vertically or horizontally oriented.

Light Pattern	Problem Description	Suggested Resolution
① ② ③ ④	The computer is in a normal "off" condition, or a possible pre-BIOS failure has occurred.  The diagnostic lights are not lit after the computer successfully boots to the operating system.	Plug the computer into a working electrical outlet and press the power button.
① ② ③ ④	A possible BIOS failure has occurred; the computer is in recovery mode.	Run the BIOS Recovery utility, wait for recovery completion, and then restart the computer.
① ② ③ ④	A possible processor failure has occurred.	Reinstall the processor and restart the computer. For information on reinstalling the processor, see your online <i>User's Guide</i> .

Light Pattern	Problem Description	Suggested Resolution
	Memory modules are detected, but a memory failure has occurred.	<ul style="list-style-type: none"> <li>• If you have one memory module installed, reinstall it and restart the computer. For information on reinstalling memory modules, see your online <i>User's Guide</i>.</li> <li>• If you have two or more memory modules installed, remove the modules, reinstall one module, and then restart the computer. If the computer starts normally, reinstall an additional module. Continue until you have identified a faulty module or reinstalled all modules without error.</li> <li>• If available, install properly working memory of the same type into your computer.</li> <li>• If the problem persists, contact Dell. For information on contacting Dell, see your online <i>User's Guide</i>.</li> </ul>
	A possible graphics card failure has occurred.	<ul style="list-style-type: none"> <li>• If the computer has a graphics card, remove the card, reinstall it, and then restart the computer.</li> <li>• If the problem still exists, install a graphics card that you know works and restart the computer.</li> <li>• If the problem persists or the computer has integrated graphics, contact Dell. For information on contacting Dell, see your online <i>User's Guide</i>.</li> </ul>
	A possible floppy or hard drive failure has occurred.	Reseat all power and data cables and restart the computer.
	A possible USB failure has occurred.	Reinstall all USB devices, check cable connections, and then restart the computer.

Light Pattern	Problem Description	Suggested Resolution
	No memory modules are detected.	<ul style="list-style-type: none"> <li>• If you have one memory module installed, reinstall it and restart the computer. For information on reinstalling memory modules, see your online <i>User's Guide</i>.</li> <li>• If you have two or more memory modules installed, remove the modules, reinstall one module, and then restart the computer. If the computer starts normally, reinstall an additional module. Continue until you have identified a faulty module or reinstalled all modules without error.</li> <li>• If available, install properly working memory of the same type into your computer.</li> <li>• If the problem persists, contact Dell. For information on contacting Dell, see your online <i>User's Guide</i>.</li> </ul>
	Memory modules are detected, but a memory configuration or compatibility error exists.	<ul style="list-style-type: none"> <li>• Ensure that no special memory module/memory connector placement requirements exist.</li> <li>• Verify that the memory modules that you are installing are compatible with your computer.</li> <li>• If the problem persists, contact Dell. For information on contacting Dell, see your online <i>User's Guide</i>.</li> </ul>
	A failure has occurred.  This pattern also displays when you enter system setup and may not indicate a problem.	<ul style="list-style-type: none"> <li>• Ensure that the cables are properly connected to the system board from the hard drive, CD drive, and DVD drive.</li> <li>• Check the computer message that appears on your monitor screen.</li> <li>• If the problem persists, contact Dell. For information on contacting Dell, see your online <i>User's Guide</i>.</li> </ul>

### Beep Codes

Your computer might emit a series of beeps during start-up if the monitor cannot display errors or problems. This series of beeps, called a beep code, identifies a problem. One possible beep code (code 1 3-1) consists of one beep, a burst of three beeps, and then one beep. This beep code tells you that the computer encountered a memory problem.

If your computer beeps during start-up:

- 1 Write down the beep code.
- 2 See "Dell Diagnostics" on page 46 to identify a more serious cause.
- 3 Contact Dell for technical assistance. For information on contacting Dell, see your online *User's Guide*.

Code	Cause	Code	Cause
1-1-2	Microprocessor register failure	3-1-4	Slave interrupt mask register failure
1-1-3	NVRAM read/write failure	3-2-2	Interrupt vector loading failure
1-1-4	ROM BIOS checksum failure	3-2-4	Keyboard Controller test failure
1-2-1	Programmable interval timer failure	3-3-1	NVRAM power loss
1-2-2	DMA initialization failure	3-3-2	Invalid NVRAM configuration
1-2-3	DMA page register read/write failure	3-3-4	Video Memory test failure
1-3	Video Memory test failure	3-4-1	Screen initialization failure
1-3-1 through 2-4-4	Memory not being properly identified or used	3-4-2	Screen retrace failure
3-1-1	Slave DMA register failure	3-4-3	Search for video ROM failure
3-1-2	Master DMA register failure	4-2-1	No timer tick
3-1-3	Master interrupt mask register failure	4-2-2	Shutdown failure
4-2-3	Gate A20 failure	4-4-1	Serial or parallel port test failure
4-2-4	Unexpected interrupt in protected mode	4-4-2	Failure to decompress code to shadowed memory
4-3-1	Memory failure above address 0FFFFh	4-4-3	Math-coprocessor test failure
4-3-3	Timer-chip counter 2 failure	4-4-4	Cache test failure
4-3-4	Time-of-day clock stopped		

### Resolving Software and Hardware Incompatibilities

If a device is either not detected during the operating system setup or is detected but incorrectly configured, you can use the Hardware Troubleshooter to resolve the incompatibility.

- 1 Click the **Start** button and click **Help and Support**.
- 2 Type `hardware troubleshooter` in the **Search** field and click the arrow to start the search.

- 3 Click **Hardware Troubleshooter** in the **Search Results** list.
- 4 In the **Hardware Troubleshooter** list, click **I need to resolve a hardware conflict on my computer**, and click **Next**.

### Using Microsoft Windows XP System Restore

The Microsoft Windows XP operating system provides System Restore to allow you to return your computer to an earlier operating state (without affecting data files) if changes to the hardware, software, or other system settings have left the computer in an undesirable operating state. See the Windows Help and Support Center for information on using System Restore. To access the Windows Help and Support Center, see "Windows Help and Support Center" on page 6.

 **NOTICE:** Make regular backups of your data files. System Restore does not monitor your data files or recover them.

#### Creating a Restore Point

- 1 Click the **Start** button and click **Help and Support**.
- 2 Click **System Restore**.
- 3 Follow the instructions on the screen.

#### Restoring the Computer to an Earlier Operating State

 **NOTICE:** Before you restore the computer to an earlier operating state, save and close any open files and exit any open programs. Do not alter, open, or delete any files or programs until the system restoration is complete.

- 1 Click the **Start** button, point to **All Programs**→**Accessories**→**System Tools**, and then click **System Restore**.
- 2 Ensure that **Restore my computer to an earlier time** is selected, and click **Next**.
- 3 Click a calendar date to which you want to restore your computer.

The **Select a Restore Point** screen provides a calendar that allows you to see and select restore points. All calendar dates with available restore points appear in boldface type.

- 4 Select a restore point and click **Next**.

If a calendar date has only one restore point, then that restore point is automatically selected. If two or more restore points are available, click the restore point that you prefer.

- 5 Click **Next**.

The **Restoration Complete** screen appears after System Restore finishes collecting data and then the computer restarts.

- 6 After the computer restarts, click **OK**.

To change the restore point, you can either repeat the steps using a different restore point, or you can undo the restoration.

### Undoing the Last System Restore

 **NOTICE:** Before you undo the last system restore, save and close all open files and exit any open programs. Do not alter, open, or delete any files or programs until the system restoration is complete.

- 1 Click the **Start** button, point to **All Programs**→**Accessories**→**System Tools**, and then click **System Restore**.
- 2 Click **Undo my last restoration** and click **Next**.
- 3 Click **Next**.  
The **System Restore** screen appears and the computer restarts.
- 4 After the computer restarts, click **OK**.

### Enabling System Restore

If you reinstall Windows XP with less than 200 MB of free hard-disk space available, System Restore is automatically disabled. To verify that System Restore is enabled:

- 1 Click the **Start** button and click **Control Panel**.
- 2 Click **Performance and Maintenance**.
- 3 Click **System**.
- 4 Click the **System Restore** tab.
- 5 Ensure that **Turn off System Restore** is unchecked.

### Reinstalling Microsoft Windows XP

#### Getting Started

 **NOTE:** The procedures in this document were written for the Windows default view in Windows XP Home Edition, so the steps will differ if you set your Dell computer to the Windows Classic view or are using Windows XP Professional.



If you are considering reinstalling the Windows XP operating system to correct a problem with a newly installed driver, first try using Windows XP Device Driver Rollback.

- 1 Click the **Start** button and click **Control Panel**.
- 2 Under **Pick a Category**, click **Performance and Maintenance**.
- 3 Click **System**.
- 4 In the **System Properties** window, click the **Hardware** tab.
- 5 Click **Device Manager**.
- 6 Right-click the device for which the new driver was installed and click **Properties**.
- 7 Click the **Drivers** tab.
- 8 Click **Roll Back Driver**.

If Device Driver Rollback does not resolve the problem, then use System Restore to return your operating system to the operating state it was in before you installed the new device driver (see "Using Microsoft Windows XP System Restore" on page 54).

 **NOTE:** The *Drivers and Utilities* CD contains drivers that were installed during assembly of the computer. Use the *Drivers and Utilities* CD to load any required drivers, including the drivers required if your computer has a RAID controller.

### Reinstalling Windows XP



-  **NOTICE:** You must use Windows XP Service Pack 1 or later when you reinstall Windows XP.
-  **NOTICE:** Before performing the installation, back up all data files on your primary hard drive. For conventional hard drive configurations, the primary hard drive is the first drive detected by the computer.

To reinstall Windows XP, you need the following items:

- Dell *Operating System* CD
- Dell *Drivers and Utilities* CD

To reinstall Windows XP, perform all the steps in the following sections in the order in which they are listed.

The reinstallation process can take 1 to 2 hours to complete. After you reinstall the operating system, you must also reinstall the device drivers, virus protection program, and other software.

-  **NOTICE:** The *Operating System* CD provides options for reinstalling Windows XP. The options can overwrite files and possibly affect programs installed on your hard drive. Therefore, do not reinstall Windows XP unless a Dell technical support representative instructs you to do so.
-  **NOTICE:** To prevent conflicts with Windows XP, disable any virus protection software installed on your computer before you reinstall Windows XP. See the documentation that came with the software for instructions.

### Booting From the Operating System CD

- 1 Save and close any open files and exit any open programs.
- 2 Insert the *Operating System* CD. Click **Exit** if the **Install Windows XP** message appears.
- 3 Restart the computer.
- 4 Press <F12> immediately after the **DELL** logo appears.  
If the operating system logo appears, wait until you see the Windows desktop, and then shut down the computer and try again.
- 5 Press the arrow keys to select **CD-ROM**, and press <Enter>.
- 6 When the **Press any key to boot from CD** message appears, press any key.



## Windows XP Setup

- 1 When the **Windows XP Setup** screen appears, press <Enter> to select **To set up Windows now**.
- 2 Read the information on the **Microsoft Windows Licensing Agreement** screen, and press <F8> to accept the license agreement.
- 3 If your computer already has Windows XP installed and you want to recover your current Windows XP data, type **r** to select the repair option, and remove the CD.
- 4 If you want to install a new copy of Windows XP, press <Esc> to select that option.
- 5 Press <Enter> to select the highlighted partition (recommended), and follow the instructions on the screen.

The **Windows XP Setup** screen appears, and the operating system begins to copy files and install the devices. The computer automatically restarts multiple times.



**NOTE:** The time required to complete the setup depends on the size of the hard drive and the speed of your computer.



**NOTICE:** Do not press any key when the following message appears: **Press any key to boot from the CD.**

- 6 When the **Regional and Language Options** screen appears, select the settings for your location and click **Next**.
- 7 Enter your name and organization (optional) in the **Personalize Your Software** screen, and click **Next**.
- 8 At the **Computer Name and Administrator Password** window, enter a name for your computer (or accept the one provided) and a password, and click **Next**.
- 9 If the **Modem Dialing Information** screen appears, enter the requested information and click **Next**.
- 10 Enter the date, time, and time zone in the **Date and Time Settings** window, and click **Next**.
- 11 If the **Networking Settings** screen appears, click **Typical** and click **Next**.
- 12 If you are reinstalling Windows XP Professional and you are prompted to provide further information regarding your network configuration, enter your selections. If you are unsure of your settings, accept the default selections.

Windows XP installs the operating system components and configures the computer. The computer automatically restarts.



**NOTICE:** Do not press any key when the following message appears: **Press any key to boot from the CD.**

- 13 When the **Welcome to Microsoft** screen appears, click **Next**.
- 14 When the **How will this computer connect to the Internet?** message appears, click **Skip**.
- 15 When the **Ready to register with Microsoft?** screen appears, select **No, not at this time** and click **Next**.
- 16 When the **Who will use this computer?** screen appears, you can enter up to five users.
- 17 Click **Next**.

- 18 Click **Finish** to complete the setup, and remove the CD.
- 19 Reinstall the appropriate drivers with the *Drivers and Utilities* CD.
- 20 Reinstall your virus protection software.
- 21 Reinstall your programs.

 **NOTE:** To reinstall and activate your Microsoft Office or Microsoft Works Suite programs, you need the Product Key number located on the back of the Microsoft Office or Microsoft Works Suite CD sleeve.

## Using the Drivers and Utilities CD

To use the *Drivers and Utilities* CD (*ResourceCD*) while you are running the Windows operating system.

 **NOTE:** To access device drivers and user documentation, you must use the *Drivers and Utilities* CD while you are running Windows.

- 1 Turn on the computer and allow it to boot to the Windows desktop.
- 2 Insert the *Drivers and Utilities* CD into the CD drive.

If you are using the *Drivers and Utilities* CD for the first time on this computer, the **ResourceCD Installation** window opens to inform you that the *Drivers and Utilities* CD is about to begin installation.

- 3 Click **OK** to continue.

To complete the installation, respond to the prompts offered by the installation program.

- 4 Click **Next** at the **Welcome Dell System Owner** screen.

Select the appropriate **System Model**, **Operating System**, **Device Type**, and **Topic**.

### Drivers for Your Computer

To display a list of device drivers for your computer:

- 1 Click **My Drivers** in the **Topic** drop-down menu.

The *Drivers and Utilities* CD (optional) scans your computer's hardware and operating system, and then a list of device drivers for your system configuration is displayed on the screen.

- 2 Click the appropriate driver and follow the instructions to download the driver to your computer.

To view all available drivers for your computer, click **Drivers** from the **Topic** drop-down menu.

# Index

## B

beep codes, 52

## C

CDs

operating system, 6

conflicts

software and hardware  
incompatibilities, 53

cover

removing, 24

## D

Dell Diagnostics, 46

Dell support site, 7

diagnostics

beep codes, 52

Dell Diagnostics, 46

documentation

End User License  
Agreement, 6

ergonomics, 6

online, 7

Product Information Guide, 6

regulatory, 6

safety, 6

User's Guide, 5

warranty, 6

drivers

list of, 58

Drivers and Utilities CD, 5

## E

End User License  
Agreement, 6

ergonomics information, 6

error messages

beep codes, 52

diagnostic lights, 50

system lights, 49

## H

hardware

beep codes, 52

conflicts, 53

Dell Diagnostics, 46

Hardware Troubleshooter, 53

Help and Support Center, 6

help file

Windows Help and Support  
Center, 6

## I

installing parts

before you begin, 25

IRQ conflicts, 53

## L

labels

Microsoft Windows, 7

Service Tag, 7

lights

diagnostic, 50

power, 14, 18

system, 49

## M

motherboard. *See* system  
board

## O

operating system

reinstalling, 6

reinstalling Windows XP, 55

Operating System CD, 6

## P

power

light, 14, 18

power light

diagnosing problems with, 49

problems. *See troubleshooting*

Product Information Guide, 6

**R**

regulatory information, 6  
reinstalling  
    Windows XP, 55

**S**

safety instructions, 6  
Service Tag, 7  
software  
    conflicts, 53  
support website, 7  
system board, 33, 36, 42  
System Restore, 54

**T**

troubleshooting  
    beep codes, 52  
    conflicts, 53  
    Dell Diagnostics, 46  
    diagnostic lights, 50  
    Hardware Troubleshooter, 53  
    Help and Support Center, 6  
    restore computer to previous  
        operating state, 54  
    system lights, 49

**U**

User's Guide, 5

**W**

warranty information, 6  
Windows XP  
    Hardware Troubleshooter, 53  
    Help and Support Center, 6  
    reinstalling, 6, 55  
    setup, 57  
    System Restore, 54